

Series 5000 Centrifugal Fans

Design 5010 Airfoil • Class IV HD
Design 5020 BI • Class IV & IV HD

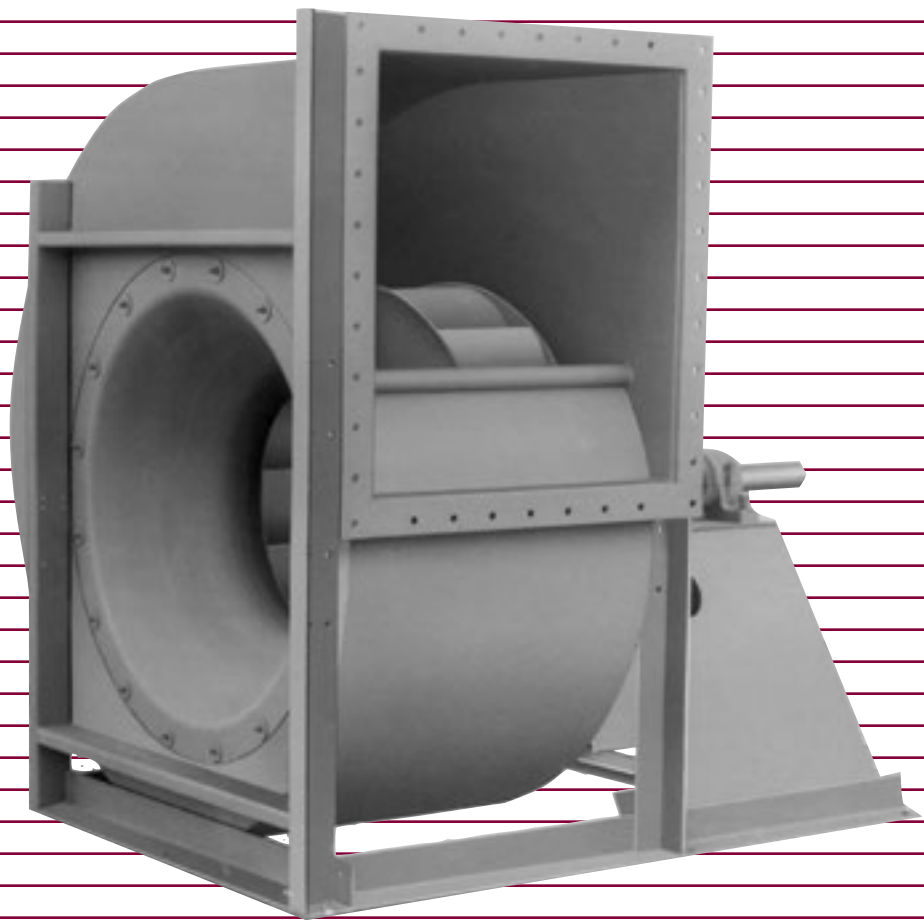

Series 5000 Centrifugal Fans

The Design 5010 and 5020 Class IV fans are highly efficient and stable operating fans suited for a broad range of rigorous industrial applications.

Industrial supply and exhaust:

Forced Draft

Combustion Air Supply

Locomotive Traction Motor Cooling

Spray Booth Supply and Exhaust

Pulp and Paper Machines

Grain Drying

Drying Kilns

General Information	2
Selection	3
Accessories	4
Performance Data	5
Dimensions	17
Sound Data	19
Fan Geometry	19
Fan Arrangements	20

Shafts and Bearings

Shafts

Selected to have suitable strength and operate well below the first critical speed for each maximum class condition.

Bearings

Antifriction, grease lubricated, roller types, split housing, manufactured to internationally adopted standards by companies having worldwide acceptance and support services. Bearings are selected for continuous belt driven operation with a generous bearing life throughout each full class range.



Classes of Construction

Arrangement	Fan Size Range	
	Class IV	Class IV HD
A/1 - SISW	2450 - 5425	2450 - 6600
A/8 - SISW *	2450 - 5425	2450 - 6600
A/9 - SISW *	2450 - 5425	2450 - 6600

*Frame size limits and constructional details upon request

Capacities

11200 CFM to 124,000 CFM

Pressures

Class IV to 22" S.P. (Size 2450 - 5425)

Class IV HD to 24" S.P. (Size 2450 - 6600)

Temperatures

Operating Temperatures to 800° F

See Table 2, Page 3

Design 5010 Centrifugal Airfoil Wheel

The Northern Blower Airfoil wheel is designed for high operating efficiency. Blades are die formed hollow airfoil sections reinforced as required for class of duty. Continuously welded steel construction is standard. Available from 24 1/2" to 66" diameters.



Design 5020 Centrifugal BI Wheel

The Northern Blower BI wheel is ruggedly designed for high operating efficiency. The blades are formed from heavy gauge single thickness material. Continuously welded steel construction is standard. Available from 24 1/2" to 66" diameters.

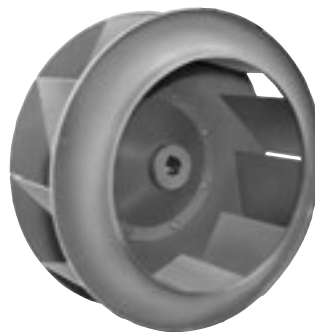

Fan Selection at Elevated Temperature and Altitude

Fan Selection Tables

Ratings shown in the Performance Tables are based on standard air density of .075 pounds per cubic foot at the fan inlet. Standard air is dry air at 70°F and 29.92" Hg barometric pressure. When air density varies from standard, due to temperature or altitude changes, the Air Density Correction Factor from Table 1 is applied. Refer to the sample selection that follows.

Note that data in the selection tables does not include the effects of accessories such as inlet dampers, outlet dampers, screens, or other components in the air stream.

High Temperature

Fans selected for high temperature service must fall within the limits for a particular arrangement as shown in Table 2. For selection, both fan performance and physical operating limits must be corrected. Refer to the sample selection on the following page.

Table 1

Air Density Correction Factor							
Air Temp °F	Elevation (Feet) above Sea Level						
	0	500	1000	2000	3000	4000	5000
-40°	.79	.81	.82	.85	.88	.92	.95
0°	.87	.88	.90	.93	.97	1.00	1.04
40°	.94	.96	.98	1.01	1.05	1.09	1.13
70°	1.00	1.02	1.04	1.08	1.12	1.16	1.20
100°	1.06	1.08	1.10	1.14	1.18	1.22	1.27
140°	1.13	1.15	1.17	1.22	1.26	1.31	1.36
180°	1.21	1.23	1.25	1.30	1.35	1.40	1.45
200°	1.25	1.27	1.29	1.34	1.39	1.44	1.50
250°	1.34	1.36	1.39	1.44	1.49	1.55	1.61
300°	1.43	1.46	1.49	1.54	1.60	1.66	1.72
350°	1.53	1.56	1.58	1.64	1.71	1.77	1.84
400°	1.62	1.65	1.68	1.75	1.81	1.88	1.95
450°	1.72	1.75	1.78	1.85	1.92	1.99	2.06
500°	1.81	1.84	1.88	1.95	2.02	2.10	2.18
600°	2.00	2.04	2.07	2.15	2.23	2.32	2.40
700°	2.19	2.23	2.27	2.35	2.44	2.53	2.63
800°	2.38	2.42	2.46	2.56	2.65	2.75	2.86

Table 2

High Temperature Operating Limits		
Arrangement	Without Cooling Wheel	With Cooling Wheel
1 SW	300°F	650°F *
8 SW	300°F	650°F *
9 SW	300°F	650°F

*800°F with cooling wheel and shaft seal.

Table 3

Wheel & Shaft Maximum Speeds at 70 °F			
Size	Design 5010	Design 5020	
	Class IV HD	Class IV	Class IV HD
2450	3196	3054	3196
2700	2850	2771	2850
3000	2610	2493	2610
3300	2373	2225	2373
3650	2145	2010	2145
4025	1945	1824	1945
4450	1760	1641	1760
4900	1598	1490	1598
5425	1443	1347	1443
6000	1305	-	1216
6600	1186	-	1106

Table 4

Safe Speed Deration Factors	
Temp °F	Alloy Steel Wheel
-50 to 150	1.0
200	.97
300	.96
400	.95
500	.94
600	.92
700	.87
800	.68

Sample Selection of a Belt Drive Fan

Select a 5010 Airfoil fan for the operating conditions of 36000 CFM at 12" SP, 200°F and 2000 feet elevation.

- 1) Multiply the Operating SP by the Air Density Correction Factor (Table 1) to obtain Equivalent SP:

$$\begin{aligned} \text{Equivalent SP} &= \text{Operating SP} \times \text{Air Density Corr. Factor} \\ &= 12" \times 1.34 = 16". \end{aligned}$$

- 2) From the Performance Tables, select the fan size. For 36000 CFM at 16" SP an efficient selection would be a size 4025 fan. Interpolating from the Performance Table given on page 7, the selected fan performance is 1776 RPM and 112.7 BHP at standard temperature and pressure.

- 3) Divide the Equivalent BHP by the Air Density Correction Factor to obtain the Operating BHP:

$$\text{Operating BHP} = \frac{\text{Equivalent BHP}}{\text{Air Density Correction Factor}}$$

$$= \frac{112.7}{1.34} = 84.1 \text{ BHP}$$

- 4) Multiply the Wheel & Shaft Maximum Speed at 70°F values (Table 3) by the Safe Speed Deration Factors (Table 4). For a 5010 Airfoil fan, size 4025, Class IV HD, the maximum speed at 200°F is:

$$\text{Max Speed} = 1945 \times 0.97 = 1886 \text{ RPM}$$

Since the fan selection speed of 1776 RPM is below the maximum allowable speeds, the Class IV HD fan is a suitable selection.

Accessories

Available with the Following Accessories

- Spark Resistant Construction
- Shaft and Bearing Guards
- Protective Coatings
- Split Housings
- Drain Openings
- High Temperature Construction
- Extended Grease Fittings
- Insulation Clips
- Mounted Drive Package
- Square Flanged Inlet
- Variable Inlet Vanes
- Outlet Damper
- Inlet Box
- Raised Access Door
- Flush Access Door
- Inlet Screen
- Cooling Wheel
- Shaft Seal
- Belt Guard
- Flanged Inlet
- Vibration Isolation Base

Due to the wide variety of airfoil and BI fans available from Northern Blower we are unable to publish all information in one bulletin. Further information on custom fans is available from your Northern Blower sales representative.

Performance Data

Wheel Diameter = 24.50 in.

Outlet Area = 3.45 sq. ft. inside

Maximum BHP = 1.59 x (RPM/1000)³

Tip Speed, fpm = 6.41 x RPM

Size

Class IVHD 3196

2450 SISW

Design 5010 Centrifugal Airfoil Fans

Volume O.Vel		12"SP		13"SP		14"SP		15"SP		16"SP		17"SP		18"SP		19"SP		20"SP		22"SP	
CFM	FPM	RPM	BHP	RPM	BHP	RPM	BHP	RPM	BHP	RPM	BHP	RPM	BHP	RPM	BHP	RPM	BHP	RPM	BHP	RPM	BHP
11200	3248	2569	26.6	2632	28.6	2693	30.5	2753	32.5	2812	34.5	2865	36.4	2919	38.3	2966	40.1	3015	42.0	3106	45.6
11300	3277	2578	26.9	2641	28.9	2701	30.8	2761	32.8	2820	34.8	2874	36.8	2928	38.8	2976	40.6	3024	42.4	3115	46.1
11400	3306	2587	27.2	2649	29.2	2710	31.2	2770	33.2	2827	35.2	2883	37.2	2936	39.1	2986	41.0	3033	42.9	3124	46.6
11500	3335	2595	27.5	2658	29.5	2719	31.5	2778	33.5	2836	35.5	2893	37.6	2945	39.5	2996	41.5	3042	43.3	3133	47.1
11600	3364	2604	27.8	2667	29.8	2728	31.8	2786	33.8	2844	35.9	2901	38.0	2954	39.9	3006	42.0	3052	43.8	3143	47.6
11700	3393	2613	28.1	2677	30.2	2736	32.2	2795	34.2	2853	36.2	2909	38.3	2963	40.3	3014	42.4	3062	44.3	3153	48.1
11800	3422	2622	28.4	2685	30.5	2745	32.5	2803	34.5	2862	36.6	2917	38.7	2972	40.8	3023	42.8	3073	44.8	3163	48.6
11900	3451	2631	28.7	2694	30.8	2754	32.8	2813	34.9	2869	36.9	2925	39.0	2981	41.2	3031	43.2	3083	45.3	3172	49.1
12000	3480	2640	29.0	2702	31.1	2763	33.2	2822	35.3	2878	37.3	2934	39.4	2989	41.6	3040	43.6	3091	45.7	3181	49.6
12200	3538	2657	29.6	2720	31.7	2781	33.9	2838	35.9	2895	38.0	2951	40.2	3004	42.3	3059	44.5	3107	46.6		
12400	3596	2676	30.2	2738	32.4	2798	34.5	2856	36.7	2913	38.8	2967	40.9	3022	43.1	3074	45.3	3126	47.5		
12600	3654	2694	30.9	2755	33.0	2815	35.2	2875	37.4	2930	39.5	2984	41.7	3038	43.9	3091	46.1	3143	48.4		
12800	3713	2713	31.5	2773	33.7	2834	35.9	2892	38.1	2947	40.3	3003	42.6	3055	44.7	3108	47.0	3159	49.2		
13000	3771	2732	32.2	2792	34.4	2851	36.6	2909	38.8	2966	41.1	3019	43.3	3072	45.6	3124	47.8	3175	50.1		
13200	3829	2752	32.9	2810	35.1	2869	37.3	2927	39.6	2983	41.9	3037	44.1	3090	46.4	3141	48.7	3193	51.0		
13400	3887	2771	33.6	2829	35.8	2887	38.1	2945	40.4	3000	42.6	3055	45.0	3107	47.3	3159	49.6				
13600	3945	2792	34.4	2848	36.5	2906	38.8	2962	41.1	3018	43.5	3072	45.8	3125	48.1	3176	50.5				
13800	4003	2813	35.2	2868	37.3	2924	39.6	2980	41.9	3036	44.3	3090	46.6	3143	49.0	3193	51.3				
14000	4061	2834	36.0	2888	38.1	2943	40.3	2999	42.7	3053	45.0	3108	47.5	3160	49.9						
14500	4206	2887	38.0	2940	40.2	2992	42.4	3045	44.7	3099	47.2	3151	49.6								
15000	4351	2941	40.2	2993	42.4	3044	44.7	3094	46.9	3146	49.3										
15500	4496	2997	42.5	3047	44.7	3096	47.0	3146	49.3	3195	51.7										
16000	4641	3053	44.8	3102	47.1	3151	49.5														
16500	4786	3110	47.3	3158	49.7																
17000	4931	3167	49.9																		

Power rating (BHP) does not include drive losses.

Performance ratings do not include the effects of appurtenances in the airstream.

Performance shown is for installation type B - Free inlet, Ducted outlet.

Wheel Diameter = 27.00 in.

Outlet Area = 4.19 sq. ft. inside

Maximum BHP = 2.58 x (RPM/1000)³

Tip Speed, fpm = 7.07 x RPM

Size

Class IVHD 2850

2700 SISW

Design 5010 Centrifugal Airfoil Fans

Volume O.Vel		12"SP		13"SP		14"SP		15"SP		16"SP		17"SP		18"SP		19"SP		20"SP		22"SP	
CFM	FPM	RPM	BHP	RPM	BHP	RPM	BHP	RPM	BHP	RPM	BHP	RPM	BHP	RPM	BHP	RPM	BHP	RPM	BHP	RPM	BHP
13600	3248	2331	32.3	2388	34.7	2443	37.0	2498	39.4	2552	41.9	2600	44.2	2648	46.6	2691	48.7	2735	51.0	2819	55.4
13800	3296	2344	32.9	2401	35.3	2456	37.7	2511	40.1	2563	42.6	2613	45.0	2662	47.4	2706	49.6	2749	51.9	2832	56.3
14000	3343	2357	33.5	2414	35.9	2470	38.4	2523	40.8	2575	43.2	2628	45.8	2674	48.1	2722	50.6	2763	52.8	2846	57.3
14200	3391	2370	34.1	2428	36.6	2482	39.0	2535	41.5	2588	44.0	2639	46.5	2688	49.0	2735	51.4	2778	53.7		
14400	3439	2384	34.7	2441	37.2	2495	39.7	2549	42.2	2601	44.7	2651	47.2	2702	49.8	2747	52.2	2794	54.8		
14600	3487	2397	35.3	2454	37.8	2509	40.4	2562	42.9	2613	45.4	2664	48.0	2713	50.6	2760	53.1	2806	55.6		
14800	3534	2410	35.9	2467	38.5	2523	41.1	2574	43.6	2626	46.1	2677	48.8	2725	51.3	2775	54.0	2819	56.5		
15000	3582	2424	36.5	2481	39.2	2535	41.7	2588	44.3	2639	46.9	2689	49.5	2738	52.1	2786	54.8	2832	57.4		
15200	3630	2438	37.2	2494	39.8	2548	42.4	2601	45.1	2652	47.7	2701	50.3	2751	53.0	2798	55.6	2846	58.3		
15400	3678	2451	37.8	2507	40.4	2561	43.1	2615	45.8	2665	48.4	2715	51.1	2763	53.7	2811	56.4				
15600	3726	2465	38.5	2520	41.1	2575	43.8	2627	46.5	2678	49.2	2728	51.9	2775	54.5	2824	57.3				
15800	3773	2480	39.2	2534	41.8	2588	44.5	2640	47.2	2692	50.0	2740	52.7	2789	55.4	2836	58.1				
16000	3821	2495	39.9	2548	42.5	2601	45.2	2654	48.0	2705	50.8	2754	53.5	2802	56.3	2848	59.0				
16200	3869	2509	40.6	2562	43.2	2615	45.9	2667	48.8	2717	51.5	2767	54.3	2815	57.1						
16400	3917	2524	41.3	2576	43.9	2629	46.7	2680	49.5	2731	52.3	2781	55.2	2828	57.9						
16600	3964	2540	42.1	2591	44.7	2642	47.4	2693	50.2	2744	53.1	2793	56.0	2841	58.8						
16800	4012	2555	42.9	2606	45.5	2656	48.2	2707	51.0	2757	53.9	2806	56.8								
17000	4060	2571	43.7	2620	46.3	2670	49.0	2721	51.8	2770	54.7	2820	57.6								
17500	4179	2610	45.7	2659	48.3	2707	51.0	2755	53.9	2805	56.8										
18000	4299	2651	47.9	2698	50.5	2745	53.2	2792	56.0	2839	58.9										
18500	4418	2692	50.0	2739	52.8	2784	55.5	2829	58.3												
19000	4537	2734	52.4	2779	55.1	2824	57.9														
19500	4657	2776	54.8	2820	57.6																
20000	4776	2818	57.3																		

Power rating (BHP) does not include drive losses.

Performance ratings do not include the effects of appurtenances in the airstream.

Performance shown is for installation type B - Free inlet, Ducted outlet.



Wheel Diameter = 30.00 in.
 Outlet Area = 5.17 sq. ft. inside
 Maximum BHP = $4.37 \times (\text{RPM}/1000)^3$
 Tip Speed, fpm = $7.85 \times \text{RPM}$

Size

3000 sisw

Class IVHD 2610

Design 5010 Centrifugal Airfoil Fans

Volume O.Vel		12"SP		13"SP		14"SP		15"SP		16"SP		17"SP		18"SP		19"SP		20"SP		22"SP	
CFM	FPM	RPM	BHP	RPM	BHP	RPM	BHP	RPM	BHP	RPM	BHP	RPM	BHP	RPM	BHP	RPM	BHP	RPM	BHP	RPM	BHP
17000	3288	2108	40.6	2159	43.5	2209	46.4	2258	49.4	2305	52.4	2350	55.4	2394	58.3	2433	61.1	2472	63.9	2547	69.4
17100	3308	2113	40.8	2164	43.8	2214	46.7	2263	49.8	2309	52.8	2355	55.8	2398	58.7	2439	61.6	2477	64.3	2552	69.8
17200	3327	2117	41.1	2169	44.1	2218	47.1	2267	50.1	2314	53.1	2360	56.2	2403	59.1	2445	62.0	2482	64.8	2557	70.3
17300	3347	2122	41.4	2174	44.4	2223	47.4	2271	50.4	2318	53.4	2366	56.6	2408	59.5	2450	62.5	2487	65.2	2562	70.8
17400	3366	2127	41.7	2179	44.7	2228	47.8	2276	50.7	2323	53.8	2370	56.9	2412	59.9	2455	63.0	2493	65.7	2567	71.4
17600	3405	2137	42.3	2189	45.4	2237	48.4	2285	51.4	2333	54.6	2378	57.6	2422	60.7	2464	63.7	2504	66.7	2578	72.4
17800	3443	2147	42.9	2198	46.0	2247	49.1	2295	52.1	2342	55.3	2387	58.4	2433	61.6	2473	64.6	2515	67.7	2588	73.4
18000	3482	2156	43.5	2207	46.6	2257	49.7	2305	52.9	2350	56.0	2396	59.1	2441	62.3	2483	65.4	2524	68.5	2598	74.4
18200	3521	2166	44.1	2217	47.3	2267	50.5	2314	53.6	2360	56.7	2406	59.9	2450	63.1	2493	66.3	2533	69.4	2609	75.4
18400	3559	2175	44.7	2227	47.9	2276	51.1	2323	54.3	2369	57.5	2415	60.6	2459	63.9	2503	67.2	2543	70.3		
18600	3598	2186	45.4	2237	48.6	2285	51.8	2333	55.0	2379	58.2	2423	61.4	2468	64.7	2511	67.9	2553	71.2		
18800	3637	2196	46.0	2246	49.2	2295	52.5	2343	55.8	2388	59.0	2433	62.2	2477	65.5	2520	68.8	2563	72.2		
19000	3675	2206	46.6	2255	49.9	2305	53.2	2353	56.5	2398	59.7	2443	63.0	2486	66.3	2529	69.6	2571	73.0		
19500	3772	2231	48.3	2281	51.6	2329	54.9	2376	58.3	2423	61.7	2466	65.0	2510	68.4	2552	71.7	2594	75.1		
20000	3869	2258	50.1	2306	53.3	2353	56.7	2401	60.2	2446	63.6	2491	67.1	2533	70.5	2575	73.9				
20500	3966	2286	52.0	2332	55.2	2378	58.6	2424	62.0	2470	65.6	2514	69.1	2557	72.6	2599	76.1				
21000	4062	2315	53.9	2359	57.2	2404	60.5	2449	64.0	2494	67.6	2538	71.2	2581	74.8						
21500	4159	2343	56.0	2387	59.2	2431	62.6	2474	66.0	2519	69.7	2562	73.3	2605	77.0						
22000	4256	2373	58.1	2416	61.4	2458	64.7	2501	68.2	2544	71.8	2586	75.5								
22500	4352	2402	60.3	2444	63.6	2487	67.0	2528	70.4	2569	74.0										
23000	4449	2432	62.5	2474	65.9	2515	69.3	2555	72.8	2596	76.4										
23500	4546	2463	64.9	2504	68.3	2544	71.7	2584	75.2												
24000	4643	2494	67.3	2534	70.7	2574	74.3														
24500	4739	2524	69.7	2565	73.3	2603	76.8														
25000	4836	2556	72.3	2595	75.8																

Power rating (BHP) does not include drive losses. Performance ratings do not include the effects of appurtenances in the airstream. Performance shown is for installation type B - Free inlet, Ducted outlet.

Wheel Diameter = 33.00 in.
 Outlet Area = 6.26 sq. ft. inside
 Maximum BHP = $7.52 \times (\text{RPM}/1000)^3$
 Tip Speed, fpm = $8.64 \times \text{RPM}$

Size

3300 sisw

Class IVHD 2373

Design 5010 Centrifugal Airfoil Fans

Volume O.Vel		12"SP		13"SP		14"SP		15"SP		16"SP		17"SP		18"SP		19"SP		20"SP		22"SP		
CFM	FPM	RPM	BHP	RPM	BHP	RPM	BHP	RPM	BHP	RPM	BHP	RPM	BHP	RPM	BHP	RPM	BHP	RPM	BHP	RPM	BHP	
20600	3291	1868	48.3	1913	51.7	1957	55.1	2001	58.6	2042	62.0	2083	65.5	2122	69.1	2161	72.7	2199	76.4	2280	84.6	
20800	3323	1875	48.9	1920	52.3	1965	55.8	2007	59.2	2048	62.7	2090	66.3	2128	69.8	2168	73.5	2205	77.1	2286	85.5	
21000	3355	1882	49.6	1927	53.0	1971	56.4	2014	59.9	2056	63.4	2096	67.0	2135	70.6	2174	74.2	2211	77.9	2292	86.3	
21200	3387	1890	50.2	1934	53.6	1978	57.1	2021	60.6	2063	64.2	2102	67.7	2142	71.4	2180	75.0	2218	78.7	2299	87.3	
21400	3419	1897	50.9	1941	54.3	1985	57.8	2028	61.3	2069	64.9	2109	68.5	2149	72.2	2186	75.7	2225	79.6	2306	88.1	
21600	3451	1904	51.5	1948	54.9	1992	58.5	2035	62.1	2076	65.6	2116	69.2	2155	72.9	2193	76.6	2231	80.3	2312	88.9	
21800	3483	1912	52.1	1956	55.6	1999	59.2	2041	62.7	2082	66.3	2123	70.0	2161	73.6	2200	77.4	2237	81.1	2318	89.7	
22000	3515	1919	52.8	1963	56.3	2006	59.9	2048	63.4	2089	67.1	2130	70.8	2168	74.4	2207	78.2	2243	81.9	2324	90.5	
22200	3547	1927	53.5	1971	57.0	2013	60.6	2055	64.2	2097	67.9	2136	71.5	2175	75.3	2213	79.0	2250	82.8	2330	91.3	
22400	3579	1935	54.2	1978	57.7	2020	61.3	2062	64.9	2103	68.6	2143	72.3	2182	76.1	2219	79.8	2257	83.7	2336	92.1	
22600	3611	1943	54.9	1985	58.4	2027	62.0	2069	65.7	2110	69.4	2150	73.1	2189	76.9	2226	80.6	2264	84.5	2342	92.9	
22800	3643	1951	55.6	1993	59.1	2035	62.8	2076	66.5	2116	70.1	2157	73.9	2195	77.7	2233	81.5	2270	85.3	2348	93.7	
23000	3675	1959	56.2	2001	59.8	2043	63.5	2083	67.2	2123	70.9	2164	74.8	2202	78.5	2240	82.4	2276	86.2	2354	94.5	
23200	3707	1967	57.0	2008	60.6	2050	64.3	2090	67.9	2131	71.7	2170	75.5	2209	79.3	2247	83.2	2283	87.1	2360	95.3	
23400	3739	1975	57.7	2017	61.4	2057	65.0	2097	68.7	2138	72.6	2177	76.3	2216	80.2	2253	84.1	2290	88.0	2366	96.1	
23600	3771	1983	58.4	2024	62.1	2065	65.8	2105	69.5	2145	73.3	2184	77.1	2223	81.1	2260	84.9	2297	88.9	2372	96.9	
23800	3802	1991	59.2	2032	62.8	2072	66.5	2113	70.4	2152	74.1	2191	78.0	2230	81.9	2267	85.8	2304	89.8			
24000	3834	2000	59.9	2040	63.6	2080	67.3	2120	71.2	2159	74.9	2198	78.8	2236	82.7	2274	86.7	2310	90.7			
25000	3994	2042	63.8	2081	67.6	2119	71.4	2158	75.3	2196	79.2	2234	83.1	2271	87.2	2308	91.2	2345	95.4			
26000	4154	2085	67.8	2123	71.7	2160	75.7	2197	79.6	2235	83.7	2271	87.7	2307	91.8	2343	95.9					
27000	4314	2130	72.1	2166	76.1	2202	80.2	2238	84.2	2274	88.3	2309	92.5	2344	96.7							
28000	4473	2176	76.7	2211	80.8	2246	84.8	2281	89.1	2315	93.2	2349	97.5									
29000	4633	2223	81.5	2257	85.6	2291	89.9	2324	94.1	2357	98.5											
30000	4793	2271	86.5	2304	90.8	2336	95.1	2369	99.5													
31000	4953	2319	91.8	2351	96.2																	

Power rating (BHP) does not include drive losses. Performance ratings do not include the effects of appurtenances in the airstream. Performance shown is for installation type B - Free inlet, Ducted outlet.



Wheel Diameter = 36.50 in.
 Outlet Area = 7.65 sq. ft. inside
 Maximum BHP = 12.5 x (RPM/1000)³
 Tip Speed, fpm = 9.56 x RPM

Class IVHD 2145

Size

3650 SISW

Design 5010 Centrifugal Airfoil Fans

Volume O.Vel		12"SP		13"SP		14"SP		15"SP		16"SP		17"SP		18"SP		19"SP		20"SP		22"SP	
CFM	FPM	RPM	BHP	RPM	BHP	RPM	BHP	RPM	BHP	RPM	BHP	RPM	BHP	RPM	BHP	RPM	BHP	RPM	BHP	RPM	BHP
26000	3395	1710	61.6	1750	65.8	1790	70.0	1828	74.4	1866	78.8	1902	83.1	1938	87.6	1972	92.0	2007	96.6	2074	105.9
26500	3461	1724	63.2	1763	67.5	1803	71.8	1841	76.2	1878	80.5	1915	85.0	1950	89.4	1985	94.0	2018	98.5	2084	107.9
27000	3526	1738	64.9	1777	69.2	1816	73.6	1854	77.9	1891	82.4	1927	86.9	1962	91.4	1997	96.0	2030	100.6	2096	110.0
27500	3591	1753	66.6	1791	70.9	1829	75.3	1867	79.8	1904	84.3	1940	88.8	1976	93.5	2009	98.0	2043	102.8	2108	112.3
28000	3657	1767	68.3	1805	72.7	1843	77.2	1880	81.7	1916	86.2	1953	90.9	1987	95.5	2022	100.2	2055	104.8	2119	114.4
28500	3722	1782	70.1	1819	74.6	1856	79.1	1893	83.6	1930	88.2	1965	92.8	2000	97.5	2034	102.3	2067	107.0	2132	116.7
29000	3787	1797	72.0	1834	76.4	1870	81.0	1907	85.6	1942	90.2	1978	94.9	2013	99.7	2046	104.4	2081	109.4	2144	119.1
29500	3853	1812	73.8	1848	78.3	1885	83.0	1920	87.6	1956	92.2	1991	97.1	2025	101.8	2059	106.7	2092	111.5		
30000	3918	1827	75.7	1863	80.3	1899	85.0	1934	89.6	1969	94.4	2004	99.2	2038	104.0	2072	108.9	2105	113.8		
30500	3983	1843	77.7	1879	82.3	1913	87.0	1949	91.7	1983	96.5	2017	101.3	2051	106.3	2084	111.2	2118	116.3		
31000	4048	1859	79.7	1894	84.3	1928	89.1	1963	93.9	1997	98.7	2031	103.7	2064	108.5	2097	113.5	2130	118.5		
31500	4114	1875	81.7	1909	86.4	1944	91.3	1977	96.0	2011	101.0	2045	105.9	2077	110.9	2111	115.9	2143	121.0		
32000	4179	1892	83.8	1926	88.6	1959	93.4	1992	98.3	2026	103.3	2058	108.2	2092	113.3	2123	118.3				
32500	4244	1908	85.9	1941	90.7	1974	95.6	2008	100.6	2040	105.5	2073	110.6	2105	115.7	2137	120.8				
33000	4310	1925	88.1	1957	92.9	1990	97.9	2023	102.9	2055	107.9	2087	113.1	2119	118.1						
33500	4375	1942	90.3	1974	95.2	2006	100.3	2038	105.2	2070	110.4	2101	115.5	2133	120.7						
34000	4440	1959	92.6	1991	97.6	2022	102.6	2054	107.7	2085	112.8	2116	118.0								
34500	4506	1976	95.0	2007	100.0	2038	105.0	2070	110.2	2100	115.3	2132	120.6								
35000	4571	1994	97.4	2024	102.4	2055	107.5	2086	112.7	2116	117.9										
35500	4636	2011	99.8	2041	104.9	2072	110.1	2102	115.2	2132	120.6										
36000	4701	2028	102.3	2059	107.5	2088	112.6	2118	117.9												
36500	4767	2046	104.8	2076	110.1	2105	115.2	2135	120.6												
37000	4832	2064	107.5	2093	112.7	2122	118.0														
38000	4963	2099	112.7	2128	118.1																
39000	5093	2135	118.2																		

Power rating (BHP) does not include drive losses. Performance ratings do not include the effects of appurtenances in the airstream. Performance shown is for installation type B - Free inlet, Ducted outlet.

Wheel Diameter = 40.25 in.
 Outlet Area = 9.31 sq. ft. inside
 Maximum BHP = 20.3 x (RPM/1000)³
 Tip Speed, fpm = 10.5 x RPM

Class IVHD 1945

Size

4025 SISW

Design 5010 Centrifugal Airfoil Fans

Volume O.Vel		12"SP		13"SP		14"SP		15"SP		16"SP		17"SP		18"SP		19"SP		20"SP		22"SP	
CFM	FPM	RPM	BHP	RPM	BHP	RPM	BHP	RPM	BHP	RPM	BHP	RPM	BHP	RPM	BHP	RPM	BHP	RPM	BHP	RPM	BHP
31000	3329	1538	72.9	1575	78.0	1612	83.2	1647	88.3	1681	93.5	1714	98.8	1746	104.1	1778	109.6	1809	114.9	1870	126.1
31500	3383	1548	74.6	1585	79.7	1621	84.8	1656	90.0	1691	95.4	1723	100.6	1755	106.0	1786	111.4	1818	116.9	1879	128.2
32000	3437	1559	76.2	1595	81.3	1630	86.5	1666	91.8	1699	97.1	1732	102.5	1765	107.9	1795	113.3	1827	119.0	1887	130.3
32500	3490	1569	77.8	1605	83.0	1640	88.3	1675	93.6	1709	98.9	1742	104.5	1773	109.8	1805	115.4	1835	120.9	1895	132.3
33000	3544	1580	79.5	1615	84.8	1650	90.0	1684	95.4	1718	100.9	1751	106.3	1783	111.8	1814	117.4	1844	123.0	1904	134.5
33500	3598	1591	81.2	1625	86.5	1660	91.8	1694	97.3	1728	102.7	1760	108.2	1793	113.9	1823	119.4	1854	125.3	1913	136.8
34000	3651	1601	82.9	1636	88.2	1670	93.7	1704	99.2	1737	104.6	1770	110.3	1801	115.9	1833	121.6	1863	127.3	1921	138.9
34500	3705	1612	84.7	1646	90.1	1680	95.6	1713	101.0	1747	106.6	1779	112.3	1811	117.9	1842	123.8	1872	129.4	1930	141.2
35000	3759	1623	86.5	1657	92.0	1690	97.4	1724	103.0	1757	108.7	1788	114.3	1820	120.1	1851	125.8	1881	131.7	1940	143.6
35500	3813	1635	88.4	1668	93.8	1701	99.4	1734	105.1	1766	110.6	1798	116.4	1830	122.2	1860	128.0	1891	134.0		
36000	3866	1646	90.2	1679	95.7	1712	101.4	1744	107.0	1776	112.7	1808	118.6	1839	124.3	1870	130.3	1900	136.2		
36500	3920	1658	92.1	1690	97.7	1723	103.4	1754	109.0	1786	114.9	1818	120.7	1849	126.6	1879	132.5	1909	138.5		
37000	3974	1669	94.1	1702	99.8	1733	105.4	1765	111.2	1797	117.0	1827	122.8	1859	128.9	1888	134.8	1919	141.0		
37500	4027	1681	96.1	1713	101.7	1744	107.5	1776	113.4	1807	119.1	1838	125.1	1868	131.1	1898	137.1	1928	143.2		
38000	4081	1693	98.1	1724	103.8	1756	109.7	1787	115.5	1817	121.4	1848	127.4	1878	133.4	1908	139.6	1937	145.6		
38500	4135	1705	100.1	1736	105.9	1767	111.8	1797	117.7	1828	123.7	1858	129.6	1888	135.8	1918	141.9				
39000	4188	1718	102.2	1748	108.1	1778	113.9	1809	119.9	1839	126.0	1868	132.0	1898	138.2	1927	144.3				
39500	4242	1730	104.4	1760	110.3	1790	116.2	1820	122.3	1849	128.2	1879	134.4	1908	140.6	1937	146.8				
40000	4296	1743	106.6	1772	112.4	1802	118.5	1831	124.5	1860	130.6	1890	136.9	1919	143.0						
41000	4403	1767	111.0	1797	117.1	1825	123.1	1854	129.2	1883	135.6	1911	141.7	1940	148.2						
42000	4511	1793	115.8	1822	121.8	1850	127.9	1878	134.3	1906	140.5	1934	146.9								
43000	4618	1819	120.6	1847	126.7	1875	133.0	1902	139.2	1929	145.7										
44000	4725	1845	125.5	1873	131.9	1899	138.1	1926	144.5												
45000	4833	1872	130.7	1898	137.1	1925	143.5														
46000	4940	1898	136.0	1924	142.5																

Power rating (BHP) does not include drive losses. Performance ratings do not include the effects of appurtenances in the airstream. Performance shown is for installation type B - Free inlet, Ducted outlet.



Wheel Diameter = 44.50 in.
 Outlet Area = 11.37 sq. ft. inside
 Maximum BHP = 33.1 x (RPM/1000)³
 Tip Speed, fpm = 11.7 x RPM

Size

4450 sisw

Class IVHD 1760

Design 5010 Centrifugal Airfoil Fans

Volume O.Vel		12"SP		13"SP		14"SP		15"SP		16"SP		17"SP		18"SP		19"SP		20"SP		22"SP	
CFM	FPM	RPM	BHP	RPM	BHP	RPM	BHP	RPM	BHP	RPM	BHP	RPM	BHP	RPM	BHP	RPM	BHP	RPM	BHP	RPM	BHP
36000	3166	1363	82.1	1398	88.0	1432	94.0	1464	99.7	1494	105.6	1525	111.5	1554	117.3	1583	123.4	1612	129.4	1670	141.9
36500	3210	1371	83.5	1405	89.6	1438	95.5	1470	101.4	1502	107.5	1531	113.2	1561	119.3	1589	125.2	1618	131.4	1675	143.9
37000	3254	1378	85.0	1412	91.0	1445	97.0	1478	103.2	1508	109.1	1538	115.1	1567	121.2	1596	127.2	1624	133.4	1680	145.9
37500	3298	1385	86.5	1419	92.5	1452	98.7	1485	104.9	1515	110.9	1545	117.1	1574	123.0	1603	129.2	1630	135.3	1686	147.9
38000	3342	1392	88.0	1426	94.1	1459	100.4	1491	106.5	1522	112.7	1552	118.9	1581	125.0	1609	131.3	1637	137.4	1692	150.0
38500	3386	1400	89.6	1433	95.7	1466	101.9	1498	108.2	1530	114.7	1559	120.7	1588	127.1	1616	133.2	1644	139.5	1698	152.3
39000	3430	1407	91.2	1440	97.3	1473	103.6	1505	110.0	1536	116.3	1566	122.7	1595	129.1	1623	135.3	1650	141.7	1704	154.4
39500	3474	1414	92.7	1447	99.0	1480	105.3	1512	111.7	1542	118.1	1573	124.7	1601	131.0	1630	137.4	1657	143.7	1710	156.6
40000	3518	1422	94.3	1455	100.7	1487	107.1	1518	113.5	1549	120.0	1580	126.6	1608	133.0	1637	139.6	1664	145.9	1717	158.9
41000	3606	1438	97.7	1469	104.0	1501	110.5	1533	117.1	1563	123.7	1593	130.4	1623	137.2	1650	143.7	1678	150.5	1730	163.6
42000	3694	1453	101.1	1485	107.6	1516	114.2	1546	120.8	1577	127.5	1607	134.4	1636	141.1	1665	148.2	1691	154.7	1743	168.2
43000	3782	1470	104.7	1500	111.2	1531	117.8	1561	124.6	1591	131.4	1620	138.3	1650	145.4	1677	152.2	1706	159.4	1758	173.3
44000	3870	1486	108.1	1516	114.9	1547	121.8	1576	128.5	1605	135.4	1635	142.5	1663	149.5	1691	156.8	1718	163.7		
45000	3958	1503	111.9	1533	118.8	1562	125.6	1591	132.6	1620	139.6	1649	146.6	1677	153.9	1705	161.0	1732	168.4		
46000	4046	1519	115.6	1549	122.6	1578	129.7	1607	136.8	1635	143.8	1664	151.1	1691	158.2	1719	165.6	1746	173.0		
47000	4134	1536	119.5	1566	126.7	1594	133.8	1622	141.0	1651	148.3	1678	155.5	1706	162.8	1733	170.2	1759	177.7		
48000	4222	1554	123.5	1582	130.7	1611	138.0	1639	145.4	1666	152.7	1693	160.1	1720	167.5	1747	175.0				
49000	4310	1571	127.5	1600	134.9	1628	142.5	1655	149.8	1682	157.3	1709	164.8	1735	172.3						
50000	4397	1589	131.7	1617	139.3	1644	146.8	1671	154.3	1698	162.0	1724	169.5	1751	177.4						
51000	4485	1608	136.1	1635	143.6	1661	151.3	1688	159.1	1714	166.7	1741	174.6								
52000	4573	1625	140.4	1652	148.1	1679	156.1	1705	163.7	1731	171.7	1757	179.5								
53000	4661	1644	144.9	1670	152.9	1696	160.7	1722	168.6	1748	176.7										
54000	4749	1662	149.7	1688	157.6	1714	165.5	1740	173.7												
55000	4837	1681	154.4	1707	162.4	1732	170.6	1757	178.7												
56000	4925	1700	159.3	1725	167.5	1750	175.7														

Power rating (BHP) does not include drive losses. Performance ratings do not include the effects of appurtenances in the airstream. Performance shown is for installation type B - Free inlet, Ducted outlet.

Wheel Diameter = 49.00 in.
 Outlet Area = 13.78 sq. ft. inside
 Maximum BHP = 53.6 x (RPM/1000)³
 Tip Speed, fpm = 12.8 x RPM

Size

4900 sisw

Class IVHD 1598

Design 5010 Centrifugal Airfoil Fans

Volume O.Vel		12"SP		13"SP		14"SP		15"SP		16"SP		17"SP		18"SP		19"SP		20"SP		22"SP	
CFM	FPM	RPM	BHP	RPM	BHP	RPM	BHP	RPM	BHP	RPM	BHP	RPM	BHP	RPM	BHP	RPM	BHP	RPM	BHP	RPM	BHP
44000	3192	1242	100.5	1274	107.8	1304	115.0	1333	122.1	1361	129.3	1388	136.4	1415	143.6	1441	150.9	1467	158.2	1519	173.4
45000	3264	1253	103.5	1284	110.7	1314	118.1	1344	125.6	1371	132.8	1398	140.1	1425	147.5	1450	154.7	1476	162.3	1527	177.5
46000	3337	1263	106.5	1294	113.9	1324	121.5	1353	128.9	1382	136.4	1409	143.9	1435	151.3	1461	158.9	1486	166.2	1536	181.6
47000	3409	1275	109.7	1305	117.1	1334	124.6	1364	132.4	1392	140.1	1419	147.6	1446	155.4	1471	162.8	1496	170.6	1545	186.1
48000	3482	1286	112.8	1315	120.3	1345	128.1	1374	135.8	1402	143.6	1430	151.6	1455	159.2	1481	167.1	1506	174.7	1554	190.3
49000	3554	1297	116.1	1327	123.8	1356	131.5	1384	139.4	1413	147.5	1439	155.3	1466	163.3	1491	171.2	1516	179.1	1564	195.0
50000	3627	1309	119.4	1338	127.1	1366	135.0	1395	143.1	1422	151.1	1450	159.2	1476	167.4	1502	175.4	1527	183.6	1574	199.6
51000	3699	1321	122.8	1349	130.7	1378	138.7	1405	146.7	1433	154.9	1460	163.2	1486	171.4	1512	179.9	1537	187.9	1584	204.3
52000	3772	1333	126.4	1361	134.3	1389	142.4	1416	150.6	1443	158.8	1470	167.1	1497	175.8	1522	184.0	1547	192.6	1595	209.4
53000	3844	1345	129.9	1373	138.0	1400	146.3	1427	154.5	1454	162.8	1481	171.4	1507	179.8	1532	188.4	1557	197.0		
54000	3917	1357	133.5	1385	141.9	1412	150.1	1439	158.4	1465	167.0	1491	175.4	1517	184.1	1543	192.8	1567	201.5		
55000	3990	1370	137.4	1397	145.7	1424	154.1	1450	162.6	1476	171.1	1502	179.7	1528	188.5	1553	197.2	1578	206.3		
56000	4062	1383	141.0	1409	149.6	1436	158.2	1462	166.7	1487	175.4	1513	184.2	1538	192.9	1563	201.9	1588	210.8		
57000	4135	1396	144.9	1422	153.7	1448	162.3	1474	171.0	1499	179.9	1524	188.6	1549	197.5	1574	206.5	1598	215.6		
58000	4207	1409	149.0	1435	157.7	1460	166.5	1486	175.4	1511	184.2	1536	193.2	1560	202.2	1584	211.2				
59000	4280	1422	153.0	1447	161.8	1473	170.9	1498	179.8	1523	188.8	1547	198.0	1571	206.9	1596	216.2				
60000	4352	1435	157.0	1460	166.1	1486	175.3	1510	184.3	1535	193.5	1559	202.6	1583	211.8						
61000	4425	1448	161.3	1474	170.5	1498	179.6	1523	188.9	1547	198.2	1571	207.4	1595	216.9						
62000	4497	1462	165.7	1487	174.9	1511	184.2	1535	193.7	1559	202.9	1583	212.5								
63000	4570	1475	170.0	1500	179.4	1524	189.0	1548	198.3	1572	207.9	1595	217.4								
64000	4642	1489	174.5	1513	184.1	1537	193.6	1561	203.2	1584	213.0										
65000	4715	1503	179.2	1527	188.8	1550	198.4	1574	208.3	1597	217.9										
66000	4787	1517	184.0	1541	193.6	1564	203.4	1587	213.2												
67000	4860	1531	188.7	1554	198.5	1578	208.6														
68000	4933	1545	193.6	1568	203.6	1591	213.5														

Power rating (BHP) does not include drive losses. Performance ratings do not include the effects of appurtenances in the airstream. Performance shown is for installation type B - Free inlet, Ducted outlet.



Wheel Diameter = 54.25 in.
 Outlet Area = 16.91 sq. ft. inside
 Maximum BHP = 89.1 x (RPM/1000)³
 Tip Speed, fpm = 14.2 x RPM

Class IVHD 1443

Size

5425 SISW

Design 5010 Centrifugal Airfoil Fans

Volume O.Vel		12"SP		13"SP		14"SP		15"SP		16"SP		17"SP		18"SP		19"SP		20"SP		22"SP		
CFM	FPM	RPM	BHP	RPM	BHP	RPM	BHP	RPM	BHP	RPM	BHP	RPM	BHP	RPM	BHP	RPM	BHP	RPM	BHP	RPM	BHP	
54000	3196	1122	123.4	1151	132.3	1178	141.1	1204	149.9	1230	158.8	1254	167.4	1278	176.3	1302	185.2	1325	194.2	1372	212.8	
55000	3255	1130	126.4	1158	135.3	1185	144.3	1212	153.4	1237	162.2	1262	171.1	1286	180.2	1309	189.0	1332	198.3	1378	216.9	
56000	3314	1138	129.3	1166	138.4	1193	147.6	1220	156.7	1245	165.8	1270	175.1	1293	183.9	1317	193.2	1339	202.2	1384	220.9	
57000	3373	1146	132.5	1174	141.6	1201	150.8	1227	160.1	1253	169.6	1277	178.6	1301	187.9	1324	197.1	1346	206.4	1391	225.3	
58000	3432	1154	135.6	1181	144.7	1208	154.1	1235	163.7	1260	173.1	1285	182.5	1309	192.0	1331	201.2	1354	210.7	1398	229.7	
59000	3491	1163	138.7	1190	148.1	1216	157.6	1242	167.1	1267	176.7	1293	186.5	1316	195.8	1339	205.6	1361	214.9	1405	234.0	
60000	3551	1171	142.1	1198	151.5	1224	160.9	1250	170.6	1275	180.5	1300	190.1	1324	200.0	1347	209.6	1369	219.3	1412	238.7	
61000	3610	1180	145.4	1206	154.9	1232	164.5	1258	174.4	1283	184.1	1307	194.0	1331	204.1	1354	213.8	1377	223.9	1420	243.4	
62000	3669	1188	148.7	1214	158.4	1240	168.2	1265	177.9	1290	187.9	1315	198.2	1338	208.0	1362	218.3	1384	228.1	1427	248.0	
63000	3728	1197	152.2	1223	162.1	1248	171.8	1273	181.7	1298	191.9	1322	201.9	1346	212.2	1369	222.5	1392	232.6	1435	252.9	
64000	3787	1206	155.9	1232	165.6	1257	175.5	1281	185.6	1306	195.7	1330	205.9	1354	216.5	1377	226.7	1400	237.4	1443	257.9	
65000	3847	1215	159.3	1240	169.3	1265	179.4	1290	189.5	1314	199.7	1338	210.2	1361	220.5	1384	231.1	1407	241.6			
66000	3906	1224	162.9	1249	173.1	1274	183.3	1298	193.4	1322	203.9	1345	214.2	1369	224.8	1392	235.6	1414	246.1			
67000	3965	1234	166.7	1258	177.0	1282	187.2	1306	197.6	1330	208.0	1353	218.5	1377	229.3	1399	239.9	1422	250.9			
68000	4024	1243	170.5	1267	180.8	1291	191.2	1315	201.8	1338	212.2	1361	222.9	1384	233.6	1407	244.4	1429	255.4			
69000	4083	1252	174.2	1276	184.8	1300	195.5	1323	205.9	1347	216.5	1370	227.3	1392	238.0	1415	249.2	1437	260.0			
70000	4142	1262	178.1	1286	188.9	1309	199.5	1332	210.1	1355	221.1	1378	231.7	1400	242.7	1422	253.7					
71000	4202	1271	182.2	1295	192.9	1318	203.6	1341	214.6	1364	225.4	1386	236.3	1409	247.4	1430	258.4					
72000	4261	1281	186.2	1304	197.0	1327	208.0	1350	219.0	1372	229.9	1395	241.1	1417	252.1	1438	263.4					
74000	4379	1301	194.4	1324	205.6	1346	216.8	1368	227.9	1390	239.4	1412	250.5	1434	262.0							
76000	4497	1321	203.2	1343	214.4	1365	225.8	1387	237.4	1408	248.7	1430	260.5									
78000	4616	1340	211.9	1362	223.5	1384	235.2	1405	246.8	1427	258.9											
80000	4734	1361	221.2	1382	233.0	1404	244.8	1425	257.0													
82000	4853	1382	230.8	1403	242.7	1424	255.0															
84000	4971	1402	240.6	1423	253.0																	

Power rating (BHP) does not include drive losses. Performance ratings do not include the effects of appurtenances in the airstream. Performance shown is for installation type B - Free inlet, Ducted outlet.

Wheel Diameter = 60.00 in.
 Outlet Area = 20.66 sq. ft. inside
 Maximum BHP = 148. X (RPM/1000)³
 Tip Speed, fpm = 15.7 x RPM

Class IVHD 1305

Size

6000 SISW

Design 5010 Centrifugal Airfoil Fans

Volume O.Vel		12"SP		13"SP		14"SP		15"SP		16"SP		17"SP		18"SP		19"SP		20"SP		22"SP	
CFM	FPM	RPM	BHP	RPM	BHP	RPM	BHP	RPM	BHP	RPM	BHP	RPM	BHP	RPM	BHP	RPM	BHP	RPM	BHP	RPM	BHP
66000	3193	1014	150.8	1040	161.7	1065	172.5	1089	183.1	1112	194.0	1134	204.6	1155	215.4	1177	226.3	1198	237.3	1241	260.1
67000	3241	1020	153.8	1046	164.7	1070	175.6	1094	186.6	1117	197.5	1139	208.3	1161	219.4	1182	230.1	1203	241.5	1245	264.3
68000	3290	1026	156.7	1051	167.7	1076	178.9	1100	190.1	1123	201.0	1145	212.2	1166	223.0	1188	234.2	1208	245.3	1249	268.2
69000	3338	1032	159.7	1057	170.9	1082	182.2	1105	193.3	1128	204.6	1151	215.9	1172	226.9	1193	238.3	1213	249.4	1254	272.4
70000	3386	1038	162.9	1063	174.1	1087	185.3	1111	196.8	1134	208.5	1156	219.6	1178	231.0	1198	242.2	1219	253.7	1259	276.9
71000	3435	1044	166.0	1069	177.2	1093	188.7	1117	200.4	1140	211.9	1162	223.4	1183	235.0	1204	246.3	1225	258.0	1264	281.2
72000	3483	1050	169.2	1075	180.5	1099	192.2	1122	203.8	1145	215.5	1168	227.5	1189	238.9	1210	250.7	1230	262.1	1269	285.5
73000	3532	1056	172.4	1081	184.0	1104	195.5	1128	207.3	1151	219.3	1173	231.1	1194	242.9	1215	254.9	1235	266.5	1275	290.1
74000	3580	1063	175.9	1087	187.3	1110	199.0	1133	210.9	1156	223.0	1178	234.9	1200	247.2	1221	258.9	1241	271.1	1281	295.0
75000	3628	1069	179.1	1093	190.7	1116	202.6	1139	214.7	1162	226.6	1184	238.9	1206	251.1	1226	263.2	1247	275.4	1286	299.5
76000	3677	1076	182.5	1099	194.3	1122	206.4	1145	218.2	1167	230.4	1190	243.0	1211	255.1	1232	267.7	1252	279.7	1291	304.1
78000	3774	1089	189.6	1112	201.5	1134	213.6	1157	225.9	1179	238.3	1201	250.7	1223	263.7	1243	276.0	1264	289.0	1303	314.2
80000	3870	1102	196.6	1125	208.9	1147	221.5	1169	233.7	1191	246.3	1212	259.1	1233	271.8	1255	285.0	1274	297.7		
82000	3967	1116	204.1	1138	216.7	1160	229.1	1181	241.9	1203	254.6	1224	267.4	1245	280.7	1265	293.6	1286	307.1		
84000	4064	1129	211.6	1151	224.4	1173	237.4	1194	250.2	1215	263.1	1236	276.4	1256	289.3	1277	302.9				
86000	4161	1144	219.4	1165	232.7	1186	245.5	1207	258.7	1228	272.1	1248	285.1	1268	298.7	1288	312.1				
88000	4257	1158	227.5	1179	240.7	1200	254.1	1220	267.6	1240	280.9	1261	294.6	1280	308.0	1300	321.8				
90000	4354	1172	235.6	1193	249.2	1213	262.9	1233	276.4	1254	290.4	1273	303.9	1293	317.8						
92000	4451	1187	244.2	1207	258.0	1227	271.7	1247	285.9	1267	299.7	1286	313.7								
94000	4548	1202	253.0	1222	266.8	1242	281.1	1261	295.2	1280	309.4	1299	323.7								
96000	4644	1216	261.9	1236	276.2	1256	290.5	1275	304.8	1294	319.5										
98000	4741	1232	271.3	1251	285.7	1270	300.1	1289	315.1												
100000	4838	1247	280.8	1266	295.3	1285	310.3	1303	325.0												
102000	4935	1262	290.5	1281	305.5	1300	320.4														
104000	5031	1278	300.7	1296	315.9																

Power rating (BHP) does not include drive losses. Performance ratings do not include the effects of appurtenances in the airstream. Performance shown is for installation type B - Free inlet, Ducted outlet.



Wheel Diameter = 66.00 in.
 Outlet Area = 25.01 sq. ft. inside
 Maximum BHP = 238. x (RPM/1000)³
 Tip Speed, fpm = 17.3 x RPM

Size

6600 SISW

Class IVHD 1186

Design 5010 Centrifugal Airfoil Fans

Volume Q.Vel		12"SP		13"SP		14"SP		15"SP		16"SP		17"SP		18"SP		19"SP		20"SP		22"SP	
CFM	FPM	RPM	BHP	RPM	BHP	RPM	BHP	RPM	BHP	RPM	BHP	RPM	BHP	RPM	BHP	RPM	BHP	RPM	BHP	RPM	BHP
80000	3199	923	182.9	946	196.1	969	209.1	990	222.1	1011	235.3	1031	248.1	1051	261.2	1070	274.4	1090	287.8	1128	315.3
81000	3239	927	185.9	950	199.0	973	212.2	995	225.6	1015	238.8	1035	251.7	1055	265.2	1074	278.2	1094	291.9	1132	319.6
82000	3279	932	188.8	954	202.0	977	215.5	999	229.2	1019	242.2	1040	255.6	1059	268.8	1078	282.2	1097	295.7	1135	323.4
83000	3319	936	191.8	959	205.2	981	218.9	1003	232.3	1024	245.8	1044	259.6	1063	272.6	1083	286.4	1101	299.7	1138	327.5
84000	3358	940	194.9	963	208.5	985	222.0	1007	235.7	1028	249.6	1048	263.1	1068	276.6	1087	290.3	1105	303.9	1142	331.8
86000	3438	950	201.2	972	214.7	994	228.6	1016	242.9	1036	256.7	1057	270.7	1076	284.7	1095	298.4	1114	312.5	1150	340.6
88000	3518	959	207.6	981	221.5	1003	235.5	1024	249.6	1045	264.0	1065	278.5	1084	292.6	1104	307.1	1122	320.9	1157	349.5
90000	3598	968	214.3	990	228.2	1011	242.4	1032	257.0	1053	271.5	1073	286.0	1093	301.1	1112	315.2	1131	330.2	1166	359.1
92000	3678	978	220.9	999	235.3	1021	249.9	1041	264.2	1061	279.0	1082	294.2	1101	308.8	1121	324.1	1139	338.6	1174	368.2
94000	3758	988	228.1	1009	242.5	1029	257.0	1050	271.8	1070	286.9	1090	301.8	1110	317.4	1129	332.4	1147	347.8	1183	378.2
96000	3838	998	235.1	1018	249.8	1039	264.7	1059	279.7	1079	294.7	1099	310.2	1118	325.5	1137	341.2	1155	356.7		
98000	3918	1008	242.3	1028	257.5	1048	272.5	1068	287.6	1088	303.1	1107	318.4	1126	334.1	1145	350.0	1164	365.7		
100000	3998	1018	250.0	1038	265.1	1058	280.4	1078	296.0	1097	311.3	1116	327.0	1135	342.9	1154	358.8	1172	375.2		
102000	4078	1029	257.4	1048	272.9	1068	288.8	1087	304.2	1106	319.9	1125	335.9	1144	351.7	1162	368.3	1180	384.3		
104000	4158	1039	265.2	1059	281.3	1078	296.9	1097	312.8	1116	328.9	1134	344.7	1153	361.2	1171	377.3				
106000	4238	1050	273.4	1069	289.3	1088	305.4	1107	321.8	1125	337.7	1144	354.1	1162	370.4	1180	387.0				
108000	4318	1061	281.4	1080	297.7	1099	314.3	1117	330.4	1135	347.0	1153	363.5	1171	380.0						
110000	4398	1072	289.7	1090	306.5	1109	322.9	1127	339.6	1145	356.5	1163	373.0	1181	390.2						
112000	4478	1083	298.5	1101	315.1	1119	331.9	1137	349.2	1155	365.8	1173	383.1								
114000	4558	1094	307.2	1112	324.1	1130	341.4	1148	358.4	1165	375.7	1183	393.0								
116000	4638	1105	316.1	1123	333.5	1141	350.7	1158	368.1	1176	385.8										
118000	4718	1116	325.5	1134	342.9	1151	360.3	1169	378.2	1186	395.7										
120000	4798	1128	335.1	1145	352.4	1163	370.3	1180	388.2												
122000	4878	1139	344.6	1156	362.4	1174	380.6														
124000	4958	1151	354.4	1168	372.7	1185	390.7														

Power rating (BHP) does not include drive losses.

Performance ratings do not include the effects of appurtenances in the airstream.

Performance shown is for installation type B - Free inlet, Ducted outlet.

Performance Data

Wheel Diameter = 24.50 in.
 Outlet Area = 3.45 sq. ft. inside
 Maximum BHP = 2.24 x (RPM/1000)³
 Tip Speed, fpm = 6.41 x RPM

Class IV 3054
 Class IVHD 3196

Size

2450 SISW

Design 5020 Backward Inclined Fan

Volume O.Vel		14"SP		15"SP		16"SP		17"SP		18"SP		19"SP		20"SP		21"SP		22"SP		24"SP	
CFM	FPM	RPM	BHP	RPM	BHP	RPM	BHP	RPM	BHP	RPM	BHP	RPM	BHP	RPM	BHP	RPM	BHP	RPM	BHP	RPM	BHP
11500	3335	2504	32.3	2561	34.3	2617	36.4	2673	38.5	2727	40.6	2782	42.7	2835	44.9						
11600	3364	2511	32.6	2568	34.7	2625	36.8	2679	38.8	2734	41.0	2788	43.1	2841	45.3						
11700	3393	2519	33.0	2576	35.1	2631	37.1	2686	39.2	2741	41.4	2794	43.5	2847	45.7						
11800	3422	2526	33.3	2583	35.4	2638	37.5	2693	39.6	2747	41.8	2800	43.9	2853	46.1	2905	48.3				
11900	3451	2534	33.7	2590	35.8	2645	37.9	2700	40.0	2753	42.1	2806	44.3	2859	46.5	2910	48.7				
12000	3480	2542	34.1	2597	36.1	2652	38.3	2707	40.4	2760	42.5	2813	44.7	2864	46.9	2916	49.2				
12200	3538	2557	34.8	2612	36.9	2668	39.1	2720	41.2	2773	43.4	2825	45.6	2877	47.8	2928	50.0	2979	52.3		
12400	3596	2573	35.5	2628	37.7	2682	39.8	2735	42.0	2787	44.2	2838	46.4	2890	48.7	2940	50.9	2991	53.2		
12600	3654	2589	36.3	2643	38.4	2697	40.6	2750	42.8	2801	45.0	2853	47.3	2903	49.5	2953	51.8	3002	54.1		
12800	3713	2604	37.0	2659	39.2	2712	41.4	2764	43.6	2816	45.9	2866	48.1	2916	50.4	2966	52.7	3014	55.0	3111	59.8
13000	3771	2620	37.8	2675	40.0	2727	42.2	2779	44.5	2830	46.8	2880	49.0	2931	51.4	2978	53.6	3028	56.0	3124	60.8
13200	3829	2637	38.7	2690	40.8	2743	43.1	2795	45.4	2845	47.6	2895	49.9	2944	52.3	2992	54.6	3040	57.0	3135	61.7
13400	3887	2653	39.5	2706	41.7	2759	44.0	2809	46.2	2860	48.5	2909	50.9	2958	53.2	3006	55.6	3053	57.9	3147	62.8
13600	3945	2669	40.3	2723	42.5	2774	44.8	2825	47.1	2876	49.5	2924	51.8	2973	54.2	3020	56.5	3068	59.0	3161	63.9
13800	4003	2687	41.2	2739	43.4	2790	45.7	2841	48.0	2890	50.3	2939	52.7	2987	55.1	3034	57.5	3081	60.0	3173	64.9
14000	4061	2703	42.0	2755	44.3	2807	46.6	2857	48.9	2906	51.3	2955	53.7	3001	56.1	3050	58.6	3095	61.0	3186	65.9
14500	4206	2745	44.3	2797	46.6	2847	48.9	2897	51.3	2945	53.7	2993	56.2	3040	58.6	3086	61.1	3131	63.6		
15000	4351	2786	46.7	2839	49.0	2889	51.4	2937	53.8	2986	56.3	3032	58.7	3079	61.3	3124	63.8	3169	66.4		
15500	4496	2828	49.2	2880	51.6	2931	54.0	2979	56.4	3026	58.9	3073	61.5	3118	64.0	3163	66.6				
16000	4641	2869	51.8	2922	54.2	2972	56.7	3021	59.2	3068	61.7	3114	64.3	3159	66.9						
16500	4786	2911	54.6	2963	57.0	3014	59.5	3062	62.1	3110	64.7	3155	67.2								
17000	4931	2956	57.5	3005	60.0	3055	62.5	3104	65.1	3151	67.7										
17500	5076	3002	60.4	3049	63.1	3097	65.6	3145	68.2	3193	70.9										
18000	5221	3051	63.6	3095	66.2	3140	68.9	3187	71.5												

Power rating (BHP) does not include drive losses. Performance ratings do not include the effects of appurtenances in the airstream. Performance shown is for installation type B - Free inlet, Ducted outlet.

Wheel Diameter = 27.00 in.
 Outlet Area = 4.19 sq. ft. inside
 Maximum BHP = 3.64 x (RPM/1000)³
 Tip Speed, fpm = 7.07 x RPM

Class IV 2771
 Class IVHD 2850

Size

2700 SISW

Design 5020 Backward Inclined Fan

Volume O.Vel		14"SP		15"SP		16"SP		17"SP		18"SP		19"SP		20"SP		21"SP		22"SP		24"SP	
CFM	FPM	RPM	BHP	RPM	BHP	RPM	BHP	RPM	BHP	RPM	BHP	RPM	BHP	RPM	BHP	RPM	BHP	RPM	BHP	RPM	BHP
14000	3343	2274	39.3	2326	41.8	2377	44.3	2427	46.9	2476	49.4	2526	52.0	2574	54.6						
14200	3391	2285	40.0	2337	42.5	2387	45.1	2437	47.6	2486	50.2	2534	52.8	2583	55.4						
14400	3439	2296	40.7	2348	43.3	2397	45.8	2447	48.4	2496	51.0	2544	53.6	2592	56.3	2639	58.9				
14600	3487	2308	41.5	2358	44.0	2408	46.6	2458	49.2	2505	51.8	2554	54.5	2600	57.1	2648	59.8				
14800	3534	2319	42.2	2370	44.7	2420	47.4	2468	49.9	2516	52.6	2563	55.3	2610	57.9	2657	60.7	2702	63.4		
15000	3582	2331	42.9	2381	45.5	2430	48.1	2478	50.7	2526	53.5	2573	56.1	2620	58.9	2665	61.5	2711	64.4		
15200	3630	2343	43.7	2392	46.3	2441	48.9	2490	51.6	2536	54.2	2583	57.0	2629	59.7	2674	62.5	2720	65.3		
15400	3678	2355	44.4	2404	47.0	2453	49.7	2500	52.4	2547	55.1	2594	57.9	2639	60.6	2685	63.4	2728	66.2	2817	71.9
15600	3726	2366	45.2	2416	47.8	2464	50.5	2511	53.2	2558	56.0	2604	58.7	2649	61.5	2694	64.3	2738	67.1	2826	72.9
15800	3773	2378	46.0	2428	48.7	2475	51.3	2522	54.1	2569	56.8	2614	59.6	2660	62.5	2703	65.2	2748	68.1	2835	73.9
16000	3821	2391	46.8	2439	49.5	2487	52.2	2534	55.0	2579	57.7	2625	60.5	2669	63.3	2714	66.2	2757	69.0	2843	74.8
16200	3869	2403	47.6	2451	50.3	2499	53.0	2545	55.8	2591	58.6	2636	61.4	2680	64.2	2725	67.2	2767	70.0		
16400	3917	2415	48.4	2463	51.2	2511	53.9	2556	56.7	2602	59.5	2647	62.3	2691	65.2	2734	68.1	2777	71.0		
16600	3964	2427	49.3	2476	52.0	2522	54.8	2568	57.6	2614	60.4	2658	63.3	2702	66.2	2745	69.1	2788	72.1		
16800	4012	2440	50.2	2488	52.9	2534	55.7	2581	58.5	2625	61.3	2669	64.2	2713	67.1	2756	70.1	2798	73.0		
17000	4060	2452	51.0	2500	53.8	2547	56.6	2592	59.4	2636	62.3	2681	65.2	2723	68.1	2767	71.1	2808	74.0		
17500	4179	2484	53.3	2531	56.1	2577	58.9	2622	61.8	2666	64.7	2709	67.6	2752	70.7	2794	73.6	2836	76.7		
18000	4299	2515	55.6	2562	58.5	2608	61.4	2652	64.3	2696	67.2	2739	70.2	2781	73.2	2822	76.3				
18500	4418	2546	58.1	2593	61.0	2639	63.9	2684	66.9	2726	69.8	2769	72.9	2810	75.9						
19000	4538	2577	60.6	2624	63.5	2671	66.5	2714	69.5	2757	72.6	2799	75.6	2840	78.7						
19500	4657	2608	63.3	2655	66.2	2701	69.2	2746	72.3	2788	75.3	2830	78.5								
20000	4776	2639	66.0	2686	69.1	2733	72.1	2776	75.1	2820	78.3										
20500	4896	2672	68.9	2718	72.0	2763	75.0	2808	78.2												
21000	5015	2706	71.8	2750	75.0	2794	78.1	2838	81.2												

Power rating (BHP) does not include drive losses. Performance ratings do not include the effects of appurtenances in the airstream. Performance shown is for installation type B - Free inlet, Ducted outlet.



Wheel Diameter = 30.00 in.
 Outlet Area = 5.17 sq. ft. inside
 Maximum BHP = 6.16 x (RPM/1000)³
 Tip Speed, fpm = 7.85 x RPM

Size

3000 sisw

Class IV 2493
 Class IVHD 2610

Design 5020 Backward Inclined Fan

Volume O.Vel		14"SP		15"SP		16"SP		17"SP		18"SP		19"SP		20"SP		21"SP		22"SP		24"SP	
CFM	FPM	RPM	BHP	RPM	BHP	RPM	BHP	RPM	BHP	RPM	BHP	RPM	BHP	RPM	BHP	RPM	BHP	RPM	BHP	RPM	BHP
17600	3405	2059	49.7	2106	52.8	2151	55.9	2195	59.0	2240	62.3	2283	65.4	2327	68.7						
17800	3443	2068	50.4	2114	53.5	2158	56.6	2203	59.8	2247	63.0	2290	66.3	2334	69.6	2376	72.9				
18000	3482	2076	51.1	2121	54.2	2166	57.4	2211	60.6	2254	63.8	2297	67.1	2340	70.4	2382	73.7				
18200	3521	2084	51.8	2130	55.0	2175	58.2	2218	61.4	2261	64.6	2304	68.0	2346	71.2	2389	74.6	2430	78.0		
18400	3559	2093	52.5	2138	55.7	2183	59.0	2226	62.2	2269	65.5	2311	68.8	2353	72.1	2395	75.5	2436	78.9		
18600	3598	2101	53.3	2147	56.5	2190	59.7	2234	63.0	2277	66.3	2318	69.6	2361	73.0	2401	76.3	2443	79.9		
18800	3637	2110	54.1	2155	57.2	2198	60.5	2242	63.8	2284	67.1	2326	70.5	2367	73.9	2408	77.3	2449	80.7		
19000	3675	2119	54.8	2163	58.0	2207	61.3	2250	64.6	2292	68.0	2334	71.4	2374	74.7	2416	78.2	2455	81.6	2535	88.6
19200	3714	2127	55.6	2171	58.8	2215	62.2	2257	65.4	2300	68.8	2341	72.2	2382	75.6	2422	79.1	2462	82.6	2541	89.6
19400	3753	2136	56.4	2180	59.7	2223	62.9	2266	66.3	2308	69.7	2348	73.1	2390	76.6	2429	80.0	2469	83.6	2548	90.7
19600	3791	2145	57.2	2189	60.5	2232	63.8	2274	67.2	2316	70.6	2356	74.0	2397	77.5	2436	80.9	2476	84.5	2554	91.6
19800	3830	2154	58.0	2197	61.3	2240	64.6	2283	68.1	2323	71.4	2365	74.9	2404	78.4	2444	81.9	2483	85.4	2560	92.6
20000	3869	2163	58.8	2206	62.1	2249	65.5	2291	68.9	2332	72.3	2373	75.9	2412	79.3	2452	82.9	2490	86.4	2567	93.6
20500	3966	2185	60.9	2229	64.3	2270	67.6	2312	71.1	2353	74.6	2392	78.1	2432	81.8	2470	85.3	2509	89.0	2585	96.3
21000	4062	2208	63.1	2250	66.4	2292	69.9	2333	73.4	2373	76.9	2413	80.6	2452	84.1	2491	87.9	2528	91.5	2602	98.9
21500	4159	2230	65.3	2274	68.8	2314	72.2	2355	75.8	2395	79.4	2434	83.0	2473	86.7	2510	90.3	2548	94.2		
22000	4256	2254	67.6	2296	71.1	2337	74.6	2377	78.2	2416	81.8	2456	85.6	2493	89.2	2531	93.1	2567	96.7		
22500	4352	2276	70.0	2319	73.6	2360	77.1	2399	80.7	2439	84.5	2477	88.1	2515	91.9	2551	95.7	2589	99.6		
23000	4449	2299	72.5	2341	76.1	2382	79.7	2423	83.4	2461	87.0	2499	90.9	2536	94.6	2573	98.5	2609	102.3		
23500	4546	2321	75.1	2364	78.7	2405	82.4	2445	86.0	2484	89.8	2521	93.6	2558	97.4	2594	101.3				
24000	4643	2344	77.8	2387	81.4	2428	85.0	2468	88.8	2506	92.6	2543	96.4	2580	100.3						
24500	4739	2367	80.5	2409	84.1	2451	87.9	2490	91.7	2529	95.5	2566	99.4	2602	103.3						
25000	4836	2390	83.3	2432	87.1	2473	90.8	2513	94.6	2552	98.5	2588	102.4								
25500	4933	2414	86.2	2455	90.0	2495	93.8	2536	97.7	2574	101.5										
26000	5029	2440	89.1	2478	93.0	2518	96.9	2558	100.8	2597	104.8										

Power rating (BHP) does not include drive losses. Performance ratings do not include the effects of appurtenances in the airstream. Performance shown is for installation type B - Free inlet, Ducted outlet.

Wheel Diameter = 33.00 in.
 Outlet Area = 6.26 sq. ft. inside
 Maximum BHP = 10.2 x (RPM/1000)³
 Tip Speed, fpm = 8.64 x RPM

Size

3300 sisw

Class IV 2225
 Class IVHD 2373

Design 5020 Backward Inclined Fan

Volume O.Vel		14"SP		15"SP		16"SP		17"SP		18"SP		19"SP		20"SP		21"SP		22"SP		24"SP	
CFM	FPM	RPM	BHP	RPM	BHP	RPM	BHP	RPM	BHP	RPM	BHP	RPM	BHP	RPM	BHP	RPM	BHP	RPM	BHP	RPM	BHP
21500	3435	1852	60.4	1896	64.3	1939	68.2	1981	72.1	2024	76.2	2064	80.3								
21600	3451	1855	60.7	1899	64.6	1941	68.5	1984	72.5	2026	76.6	2066	80.7								
21700	3467	1858	61.1	1902	64.9	1944	68.8	1986	72.9	2028	77.0	2069	81.0	2110	85.3						
21800	3483	1861	61.4	1904	65.3	1947	69.2	1989	73.3	2030	77.3	2071	81.4	2112	85.7						
21900	3499	1864	61.8	1907	65.6	1949	69.6	1992	73.7	2032	77.7	2073	81.8	2114	86.0						
22000	3515	1867	62.1	1909	66.0	1952	69.9	1994	74.0	2035	78.0	2076	82.2	2116	86.4						
22200	3547	1872	62.8	1915	66.7	1957	70.7	1999	74.7	2040	78.8	2081	83.1	2120	87.2						
22400	3579	1878	63.5	1921	67.4	1963	71.4	2004	75.5	2045	79.6	2085	83.8	2124	88.0	2164	92.3				
22600	3611	1884	64.2	1927	68.2	1968	72.1	2009	76.2	2050	80.4	2089	84.6	2129	88.9	2168	93.1				
22800	3643	1890	65.0	1932	68.9	1973	72.9	2014	77.0	2054	81.2	2094	85.4	2134	89.7	2172	93.9	2212	98.4		
23000	3675	1896	65.7	1937	69.6	1979	73.7	2020	77.8	2059	81.9	2099	86.2	2138	90.5	2177	94.8	2215	99.2		
23500	3755	1911	67.6	1952	71.6	1993	75.7	2033	79.8	2073	84.0	2111	88.3	2150	92.6	2189	97.0	2226	101.4		
24000	3834	1927	69.6	1967	73.6	2007	77.6	2047	81.9	2086	86.1	2124	90.4	2163	94.8	2200	99.2	2238	103.7	2311	112.8
24500	3914	1943	71.6	1983	75.6	2022	79.8	2061	83.9	2099	88.2	2137	92.6	2175	96.9	2213	101.5	2249	105.9	2322	115.1
25000	3994	1959	73.7	1999	77.8	2037	81.9	2076	86.1	2113	90.4	2151	94.8	2189	99.3	2225	103.7	2262	108.4	2334	117.7
25500	4074	1976	75.9	2014	79.9	2053	84.1	2090	88.4	2128	92.7	2165	97.1	2201	101.5	2238	106.2	2274	110.7	2345	120.0
26000	4154	1992	78.1	2031	82.3	2068	86.4	2106	90.7	2143	95.1	2179	99.4	2216	104.0	2251	108.5	2287	113.2	2357	122.7
26500	4234	2010	80.5	2047	84.6	2084	88.8	2122	93.1	2158	97.4	2194	101.9	2229	106.4	2265	111.0	2300	115.7	2369	125.2
27000	4314	2027	82.8	2064	87.0	2101	91.3	2137	95.5	2173	99.9	2209	104.4	2244	109.0	2279	113.6	2313	118.3		
27500	4394	2044	85.3	2081	89.5	2117	93.7	2154	98.5	2189	102.5	2224	107.0	2259	111.6	2293	116.2	2328	121.0		
28000	4473	2063	87.9	2098	92.0	2134	96.3	2170	100.7	2205	105.1	2240	109.7	2274	114.2	2308	119.0	2341	123.7		
29000	4633	2099	93.1	2134	97.4	2169	101.7	2204	106.2	2238	110.7	2272	115.2	2305	119.9	2338	124.6	2371	129.4		
30000	4793	2137	98.7	2171	103.1	2205	107.5	2238	111.9	2272	116.5	2304	121.1	2337	125.8	2370	130.6				
31000	4953	2176	104.6	2208	109.0	2241	113.5	2274	118.1	2306	122.6	2339	127.4	2370	132.1						
32000	5113	2216	110.7	2247	115.3	2279	119.9	2310	124.5	2342	129.2										

Power rating (BHP) does not include drive losses. Performance ratings do not include the effects of appurtenances in the airstream. Performance shown is for installation type B - Free inlet, Ducted outlet.



Performance Data

Wheel Diameter = 36.50 in.
 Outlet Area = 7.65 sq. ft. inside
 Maximum BHP = 16.9 x (RPM/1000)³
 Tip Speed, fpm = 9.56 x RPM

Class IV 2010
 Class IVHD 2145

Size

3650 SISW

Design 5020 Backward Inclined Fan

Volume O.Vel		14"SP		15"SP		16"SP		17"SP		18"SP		19"SP		20"SP		21"SP		22"SP		24"SP	
CFM	FPM	RPM	BHP	RPM	BHP	RPM	BHP	RPM	BHP	RPM	BHP	RPM	BHP	RPM	BHP	RPM	BHP	RPM	BHP	RPM	BHP
26000	3395	1669	72.8	1708	77.5	1748	82.4	1786	87.2	1824	92.1	1862	97.2								
26500	3461	1679	74.5	1718	79.3	1757	84.1	1795	89.0	1833	94.0	1869	99.0								
27000	3526	1689	76.3	1728	81.0	1766	85.9	1804	90.8	1841	95.8	1878	101.0	1914	106.0						
27500	3591	1700	78.0	1739	82.9	1776	87.7	1813	92.7	1850	97.8	1886	102.9	1922	108.1	1958	113.3				
28000	3657	1711	79.9	1749	84.7	1786	89.6	1823	94.7	1859	99.7	1895	104.9	1931	110.2	1966	115.4	2001	120.9		
28500	3722	1722	81.7	1760	86.6	1797	91.6	1833	96.6	1869	101.7	1905	107.0	1939	112.2	1975	117.6	2008	122.9		
29000	3787	1734	83.7	1771	88.6	1807	93.5	1843	98.6	1879	103.8	1914	109.0	1949	114.4	1983	119.7	2017	125.2		
29500	3853	1746	85.7	1782	90.6	1818	95.6	1854	100.7	1888	105.9	1923	111.2	1958	116.5	1992	121.9	2025	127.4	2091	138.6
30000	3918	1757	87.7	1793	92.6	1829	97.7	1864	102.8	1899	108.0	1933	113.4	1967	118.7	2001	124.3	2034	129.7	2099	140.9
30500	3983	1769	89.8	1805	94.8	1840	99.8	1875	105.0	1909	110.3	1943	115.6	1977	121.1	2010	126.5	2043	132.2	2108	143.5
31000	4048	1782	92.0	1816	96.9	1851	102.0	1886	107.2	1919	112.5	1953	117.9	1986	123.3	2020	128.9	2052	134.5	2116	145.9
31500	4114	1794	94.2	1829	99.2	1863	104.3	1897	109.5	1930	114.8	1964	120.2	1996	125.7	2029	131.3	2061	136.9	2125	148.4
32000	4179	1806	96.5	1841	101.5	1875	106.6	1908	111.8	1942	117.2	1974	122.6	2007	128.2	2039	133.7	2072	139.5	2135	151.1
32500	4244	1819	98.8	1853	103.8	1887	109.0	1920	114.3	1953	119.6	1985	125.1	2017	130.6	2049	136.3	2081	141.9	2143	153.6
33000	4310	1832	101.2	1865	106.3	1899	111.5	1931	116.7	1964	122.1	1996	127.6	2028	133.1	2060	138.8	2091	144.5		
33500	4375	1845	103.6	1878	108.8	1911	113.9	1943	119.2	1976	124.7	2007	130.1	2039	135.8	2070	141.4	2102	147.3		
34000	4440	1858	106.2	1891	111.3	1923	116.5	1956	121.9	1987	127.2	2019	132.8	2050	138.4	2081	144.1	2112	149.9		
34500	4506	1871	108.7	1904	113.9	1936	119.2	1968	124.5	1999	129.9	2031	135.5	2061	141.1	2092	146.9	2122	152.7		
35000	4571	1885	111.4	1917	116.6	1949	121.9	1980	127.2	2012	132.8	2042	138.2	2073	144.0	2103	149.7	2133	155.6		
35500	4636	1898	114.1	1930	119.3	1961	124.6	1993	130.0	2024	135.5	2054	141.1	2085	146.8	2114	152.6	2144	158.5		
36000	4701	1912	116.9	1943	122.1	1975	127.4	2006	132.9	2036	138.4	2067	144.1	2096	149.7	2126	155.6				
36500	4767	1926	119.6	1957	124.9	1988	130.4	2018	135.7	2049	141.3	2079	146.9	2108	152.7	2138	158.5				
37000	4832	1940	122.5	1971	127.9	2001	133.3	2031	138.7	2061	144.4	2091	150.0	2121	155.8						
38000	4963	1969	128.5	1999	133.8	2028	139.4	2058	144.9	2087	150.5	2116	156.3	2145	162.0						
39000	5093	1999	134.5	2027	140.1	2056	145.7	2085	151.3	2113	157.1	2142	162.8								

Power rating (BHP) does not include drive losses. Performance ratings do not include the effects of appurtenances in the airstream. Performance shown is for installation type B - Free inlet, Ducted outlet.

Wheel Diameter = 40.25 in.
 Outlet Area = 9.31 sq. ft. inside
 Maximum BHP = 27.5 x (RPM/1000)³
 Tip Speed, fpm = 10.5 x RPM

Class IV 1824
 Class IVHD 1945

Size

4025 SISW

Design 5020 Backward Inclined Fan

Volume O.Vel		14"SP		15"SP		16"SP		17"SP		18"SP		19"SP		20"SP		21"SP		22"SP		24"SP	
CFM	FPM	RPM	BHP	RPM	BHP	RPM	BHP	RPM	BHP	RPM	BHP	RPM	BHP	RPM	BHP	RPM	BHP	RPM	BHP	RPM	BHP
32000	3437	1519	89.9	1555	95.7	1590	101.4	1625	107.4	1659	113.5	1693	119.5								
32500	3490	1527	91.6	1562	97.3	1597	103.2	1632	109.3	1665	115.3	1699	121.4	1732	127.7						
33000	3544	1535	93.3	1570	99.1	1604	105.1	1638	111.1	1672	117.1	1706	123.5	1738	129.6						
33500	3598	1543	95.1	1578	101.0	1612	106.9	1645	112.9	1679	119.2	1711	125.3	1744	131.7	1776	138.1				
34000	3651	1551	97.0	1585	102.8	1619	108.8	1653	114.9	1685	121.1	1718	127.3	1751	133.8	1782	140.1	1814	146.8		
34500	3705	1559	98.8	1593	104.7	1627	110.7	1660	116.8	1692	123.0	1725	129.5	1757	135.8	1789	142.3	1819	148.8		
35000	3759	1568	100.7	1601	106.7	1634	112.7	1667	118.8	1700	125.2	1732	131.5	1763	137.9	1795	144.5	1826	151.0		
35500	3813	1576	102.7	1610	108.6	1642	114.7	1675	120.9	1707	127.2	1739	133.5	1771	140.2	1801	146.6	1832	153.4	1893	166.9
36000	3866	1585	104.7	1618	110.6	1650	116.8	1683	123.0	1714	129.3	1746	135.8	1777	142.2	1808	148.9	1838	155.5	1898	169.1
36500	3920	1594	106.7	1626	112.7	1659	118.9	1690	125.1	1722	131.5	1753	137.9	1784	144.5	1815	151.2	1845	157.8	1904	171.5
37000	3974	1603	108.8	1635	114.9	1667	121.0	1698	127.3	1730	133.7	1760	140.1	1792	146.8	1821	153.4	1852	160.3	1911	174.1
37500	4027	1612	111.0	1644	117.0	1675	123.2	1707	129.6	1737	135.9	1768	142.4	1799	149.1	1828	155.8	1858	162.6	1917	176.4
38000	4081	1621	113.2	1653	119.2	1684	125.5	1715	131.7	1746	138.2	1776	144.8	1806	151.4	1836	158.3	1865	165.0	1923	178.9
38500	4135	1630	115.4	1662	121.5	1693	127.7	1723	134.0	1754	140.6	1784	147.1	1814	153.8	1843	160.6	1872	167.5	1930	181.5
39000	4188	1640	117.7	1671	123.8	1701	130.0	1732	136.4	1762	142.9	1792	149.5	1821	156.3	1850	163.0	1880	170.1	1937	184.2
39500	4242	1649	120.1	1680	126.2	1710	132.4	1741	138.9	1770	145.3	1800	152.0	1829	158.7	1858	165.6	1887	172.5	1943	186.6
40000	4296	1659	122.4	1689	128.6	1720	134.9	1749	141.3	1779	147.8	1808	154.5	1837	161.2	1866	168.2	1894	175.1		
40500	4349	1668	124.9	1699	131.1	1729	137.4	1758	143.8	1788	150.4	1816	157.0	1845	163.9	1874	170.7	1902	177.8		
41000	4403	1678	127.4	1708	133.6	1738	139.9	1767	146.4	1796	153.0	1825	159.6	1854	166.5	1881	173.4	1910	180.5		
41500	4457	1688	130.0	1718	136.1	1747	142.5	1776	149.0	1805	155.6	1834	162.4	1862	169.1	1890	176.2	1917	183.1		
42000	4511	1698	132.5	1727	138.7	1757	145.2	1785	151.6	1814	158.3	1842	165.0	1870	171.9	1898	178.9	1925	185.9		
43000	4618	1718	137.8	1747	144.2	1775	150.6	1804	157.1	1832	163.8	1860	170.6	1888	177.6	1915	184.5	1942	191.7		
44000	4725	1739	143.3	1767	149.7	1795	156.3	1823	162.8	1850	169.6	1878	176.4	1905	183.3	1932	190.5				
45000	4833	1760	149.0	1787	155.6	1815	162.1	1842	168.8	1869	175.6	1896	182.4	1923	189.5						
46000	4940	1781	154.9	1808	161.5	1835	168.2	1862	175.0	1888	181.7	1915	188.8								

Power rating (BHP) does not include drive losses. Performance ratings do not include the effects of appurtenances in the airstream. Performance shown is for installation type B - Free inlet, Ducted outlet.



Wheel Diameter = 44.50 in.
 Outlet Area = 11.37 sq. ft. inside
 Maximum BHP = 45.1 x (RPM/1000)³
 Tip Speed, fpm = 11.7 x RPM

Size

4450 sisw

Class IV 1641
 Class IVHD 1760

Design 5020 Backward Inclined Fan

Volume O.Vel		14"SP		15"SP		16"SP		17"SP		18"SP		19"SP		20"SP		21"SP		22"SP		24"SP	
CFM	FPM	RPM	BHP	RPM	BHP	RPM	BHP	RPM	BHP	RPM	BHP	RPM	BHP	RPM	BHP	RPM	BHP	RPM	BHP	RPM	BHP
38000	3342	1363	103.4	1395	109.9	1427	116.6	1458	123.4	1487	130.0	1517	136.9	1546	143.6						
38500	3386	1369	105.0	1401	111.6	1433	118.4	1463	125.1	1493	131.9	1522	138.8	1551	145.6						
39000	3430	1375	106.7	1407	113.4	1438	120.1	1468	126.9	1498	133.9	1527	140.7	1556	147.7	1584	154.7				
39500	3474	1381	108.6	1412	115.1	1443	121.9	1474	128.8	1503	135.7	1532	142.7	1561	149.8	1589	156.8				
40000	3518	1387	110.3	1418	116.9	1449	123.7	1479	130.7	1508	137.6	1538	144.8	1566	151.7	1594	159.0	1621	166.1		
40500	3562	1393	112.1	1424	118.8	1454	125.7	1484	132.5	1514	139.6	1543	146.7	1571	153.8	1599	161.1	1626	168.3		
41000	3606	1399	114.0	1430	120.7	1460	127.5	1490	134.5	1519	141.7	1548	148.7	1576	156.1	1604	163.2	1631	170.6		
41500	3650	1406	115.9	1436	122.6	1466	129.4	1496	136.5	1524	143.6	1553	150.8	1581	158.1	1609	165.4	1636	172.8		
42000	3694	1412	117.8	1442	124.5	1472	131.4	1501	138.5	1530	145.6	1559	153.0	1586	160.2	1614	167.7	1641	175.0	1694	189.9
42500	3738	1418	119.7	1448	126.5	1478	133.4	1507	140.4	1536	147.7	1564	155.0	1592	162.4	1619	169.9	1646	177.3	1699	192.4
43000	3782	1425	121.7	1455	128.6	1484	135.4	1513	142.5	1541	149.8	1569	157.1	1598	164.7	1624	172.0	1652	179.7	1704	195.0
43500	3826	1432	123.8	1461	130.6	1490	137.5	1519	144.7	1547	151.9	1575	159.3	1603	166.8	1630	174.3	1657	182.0	1709	197.3
44000	3870	1438	125.9	1467	132.7	1496	139.7	1525	146.8	1553	154.0	1581	161.6	1608	169.0	1635	176.7	1662	184.2	1713	199.7
45000	3958	1451	130.1	1481	137.1	1509	144.0	1537	151.2	1565	158.6	1592	165.9	1619	173.6	1646	181.2	1673	189.1	1724	204.9
46000	4046	1465	134.5	1494	141.4	1522	148.6	1550	155.9	1577	163.1	1604	170.7	1630	178.2	1657	186.1	1683	193.9	1734	209.8
47000	4134	1479	139.0	1507	146.1	1535	153.3	1562	160.5	1589	168.0	1616	175.4	1642	183.2	1668	190.9	1694	198.9	1745	215.1
48000	4222	1494	143.7	1521	150.8	1548	158.0	1576	165.5	1602	172.9	1628	180.5	1654	188.2	1680	196.0	1705	204.0	1755	220.3
49000	4310	1508	148.6	1535	155.7	1562	163.1	1589	170.5	1615	178.0	1641	185.7	1666	193.4	1692	201.3	1717	209.3		
50000	4397	1522	153.8	1550	160.9	1576	168.1	1602	175.7	1628	183.3	1654	191.0	1679	198.8	1704	206.7	1729	214.8		
51000	4485	1538	159.1	1564	166.1	1590	173.5	1616	181.0	1641	188.7	1667	196.6	1692	204.3	1717	212.4	1741	220.4		
52000	4573	1553	164.7	1579	171.7	1604	179.0	1630	186.5	1656	194.4	1680	202.1	1705	210.2	1729	218.1	1754	226.3		
53000	4661	1568	170.5	1594	177.5	1619	184.7	1644	192.3	1669	200.0	1694	208.0	1718	216.0	1742	224.1				
54000	4749	1584	176.5	1609	183.5	1634	190.8	1659	198.2	1683	206.0	1708	214.0	1731	222.0	1755	230.2				
55000	4837	1599	182.5	1624	189.8	1649	197.0	1673	204.4	1698	212.2	1721	220.1	1746	228.3						
56000	4925	1616	188.8	1640	196.1	1664	203.4	1688	210.9	1712	218.5	1736	226.5	1759	234.6						

Power rating (BHP) does not include drive losses. Performance ratings do not include the effects of appurtenances in the airstream. Performance shown is for installation type B - Free inlet, Ducted outlet.

Wheel Diameter = 49.00 in.
 Outlet Area = 13.78 sq. ft. inside
 Maximum BHP = 73.1 x (RPM/1000)³
 Tip Speed, fpm = 12.8 x RPM

Size

4900 sisw

Class IV 1490
 Class IVHD 1598

Design 5020 Backward Inclined Fan

Volume O.Vel		14"SP		15"SP		16"SP		17"SP		18"SP		19"SP		20"SP		21"SP		22"SP		24"SP	
CFM	FPM	RPM	BHP	RPM	BHP	RPM	BHP	RPM	BHP	RPM	BHP	RPM	BHP	RPM	BHP	RPM	BHP	RPM	BHP	RPM	BHP
46000	3337	1237	125.1	1266	133.0	1295	141.1	1323	149.3	1350	157.3	1377	165.6	1404	173.9						
46500	3373	1242	126.7	1271	134.7	1299	142.9	1327	151.0	1354	159.2	1381	167.6	1407	175.8						
47000	3409	1246	128.4	1275	136.5	1303	144.6	1331	152.8	1358	161.2	1385	169.5	1411	177.9						
47500	3446	1250	130.2	1279	138.3	1307	146.4	1335	154.7	1362	163.1	1388	171.4	1415	180.1	1440	188.4				
48000	3482	1255	132.0	1283	140.0	1311	148.2	1339	156.6	1366	164.9	1392	173.4	1418	182.0	1444	190.5				
48500	3518	1259	133.7	1288	141.7	1316	150.0	1343	158.5	1370	166.8	1397	175.6	1422	184.0	1448	192.8	1472	201.4		
49000	3554	1264	135.5	1292	143.6	1320	152.0	1347	160.3	1374	168.9	1400	177.5	1426	186.1	1451	194.9	1476	203.5		
49500	3591	1269	137.4	1297	145.5	1324	153.8	1351	162.2	1378	171.0	1404	179.4	1430	188.3	1455	196.9	1480	205.8		
50000	3627	1273	139.3	1301	147.4	1328	155.7	1355	164.2	1382	172.8	1408	181.5	1434	190.5	1459	199.1	1484	208.2		
51000	3699	1283	143.1	1310	151.2	1337	159.7	1364	168.2	1390	176.8	1416	185.8	1441	194.5	1467	203.7	1491	212.5	1539	230.7
52000	3772	1292	147.1	1320	155.4	1346	163.7	1372	172.2	1399	181.1	1424	189.9	1450	199.0	1474	208.0	1499	217.2	1546	235.7
53000	3844	1303	151.2	1329	159.4	1355	167.8	1382	176.6	1407	185.2	1433	194.3	1457	203.3	1482	212.5	1506	221.8	1553	240.4
54000	3917	1312	155.3	1339	163.7	1365	172.3	1390	180.8	1416	189.7	1441	198.7	1466	207.8	1490	217.2	1514	226.5	1561	245.4
55000	3990	1323	159.6	1349	168.1	1374	176.6	1400	185.4	1425	194.2	1449	203.2	1474	212.6	1498	221.8	1523	231.5	1569	250.6
56000	4062	1333	164.1	1359	172.5	1384	181.2	1409	190.0	1434	198.8	1459	208.1	1483	217.2	1507	226.8	1530	236.2	1577	255.5
57000	4135	1343	168.6	1369	177.2	1394	185.9	1419	194.7	1444	203.8	1467	212.8	1492	222.1	1515	231.6	1539	241.2	1585	260.8
58000	4207	1354	173.3	1379	181.9	1404	190.7	1429	199.7	1453	208.6	1477	217.8	1500	227.2	1524	236.6	1547	246.4	1593	266.0
59000	4280	1365	178.2	1390	186.7	1414	195.7	1439	204.6	1462	213.7	1486	223.0	1509	232.3	1533	242.0	1556	251.5		
60000	4352	1376	183.2	1400	191.8	1425	200.7	1449	209.7	1473	219.1	1496	228.2	1519	237.7	1542	247.2	1565	257.0		
61000	4425	1387	188.4	1411	197.0	1435	205.8	1459	215.1	1482	224.2	1505	233.6	1528	243.1	1551	252.7	1573	262.5		
62000	4497	1398	193.8	1422	202.3	1446	211.2	1469	220.4	1492	229.7	1516	239.2	1538	248.7	1561	258.5	1582	268.1		
64000	4642	1421	205.2	1444	213.7	1467	222.5	1490	231.6	1513	241.0	1535	250.6	1558	260.3	1580	270.1				
66000	4787	1444	217.1	1467	225.7	1490	234.5	1512	243.6	1534	253.0	1556	262.6	1578	272.5						
68000	4933	1468	229.6	1490	238.5	1512	247.3	1534	256.4	1556	265.6	1578	275.3								
70000	5078	1493	242.3	1514	251.7	1536	260.8	1557	269.9	1578	279.2										

Power rating (BHP) does not include drive losses. Performance ratings do not include the effects of appurtenances in the airstream. Performance shown is for installation type B - Free inlet, Ducted outlet.



Wheel Diameter = 54.25 in.
 Outlet Area = 16.91 sq. ft. inside
 Maximum BHP = 122. x (RPM/1000)³
 Tip Speed, fpm = 14.2 x RPM

Class IV 1347
 Class IVHD 1443

Size

5425 SISW

Design 5020 Backward Inclined Fan

Volume O.Vel		14"SP		15"SP		16"SP		17"SP		18"SP		19"SP		20"SP		21"SP		22"SP		24"SP	
CFM	FPM	RPM	BHP	RPM	BHP	RPM	BHP	RPM	BHP	RPM	BHP	RPM	BHP	RPM	BHP	RPM	BHP	RPM	BHP	RPM	BHP
56000	3314	1115	152.2	1142	161.8	1167	171.5	1193	181.6	1218	191.4	1242	201.5								
57000	3373	1121	155.4	1148	165.1	1174	175.2	1199	185.1	1223	195.2	1248	205.5	1271	215.5						
58000	3432	1128	158.8	1154	168.7	1179	178.6	1204	188.7	1229	199.2	1253	209.2	1277	219.7	1299	230.0				
59000	3491	1135	162.4	1160	172.1	1185	182.2	1211	192.7	1235	202.8	1259	213.3	1282	223.7	1305	234.3				
60000	3551	1141	165.9	1167	175.8	1192	186.1	1216	196.2	1241	206.7	1264	217.3	1287	227.8	1311	238.7	1333	249.2		
61000	3610	1148	169.6	1173	179.6	1198	189.7	1222	200.1	1247	210.8	1270	221.3	1294	232.2	1316	242.8	1339	253.9		
62000	3669	1155	173.5	1180	183.4	1204	193.6	1229	204.2	1252	214.6	1276	225.5	1299	236.3	1322	247.2	1344	258.2	1387	280.3
63000	3728	1162	177.3	1187	187.3	1211	197.7	1235	208.1	1259	218.8	1282	229.7	1305	240.6	1328	251.8	1349	262.7	1392	285.1
64000	3787	1169	181.3	1194	191.5	1218	201.7	1241	212.2	1265	223.1	1288	233.9	1311	245.2	1333	256.1	1355	267.6	1398	290.2
65000	3847	1177	185.5	1201	195.5	1224	205.9	1248	216.6	1271	227.2	1294	238.3	1317	249.4	1339	260.7	1361	272.0	1403	294.8
66000	3906	1184	189.6	1208	199.8	1232	210.3	1255	220.8	1278	231.6	1300	242.7	1323	253.9	1345	265.4	1366	276.7	1409	299.8
67000	3965	1191	193.8	1215	204.3	1238	214.6	1261	225.3	1284	236.2	1307	247.2	1329	258.6	1351	269.9	1373	281.7	1415	305.1
68000	4024	1199	198.3	1222	208.6	1245	219.1	1269	230.0	1291	240.7	1313	251.9	1335	263.2	1357	274.7	1378	286.4	1420	309.9
69000	4083	1207	202.7	1230	213.1	1253	223.9	1275	234.5	1298	245.5	1320	256.7	1341	267.9	1363	279.7	1384	291.2	1426	315.0
70000	4142	1214	207.2	1238	217.8	1260	228.5	1282	239.3	1305	250.5	1326	261.5	1348	273.0	1369	284.5	1391	296.4	1432	320.5
71000	4202	1222	212.0	1245	222.6	1267	233.2	1290	244.3	1312	255.3	1333	266.5	1355	278.0	1376	289.5	1397	301.5	1438	325.6
72000	4261	1230	216.8	1253	227.3	1275	238.2	1297	249.2	1319	260.3	1340	271.8	1361	283.0	1382	294.9	1403	306.6		
73000	4320	1238	221.8	1261	232.3	1283	243.3	1304	254.2	1326	265.5	1347	276.8	1368	288.4	1389	300.1	1409	312.0		
74000	4379	1246	226.9	1269	237.5	1290	248.3	1312	259.4	1333	270.8	1354	282.1	1375	293.9	1395	305.4	1416	317.6		
75000	4438	1255	232.2	1276	242.7	1298	253.5	1320	264.9	1340	276.1	1362	287.7	1382	299.2	1402	311.1	1423	323.0		
76000	4497	1263	237.6	1284	248.0	1306	259.0	1327	270.2	1348	281.5	1369	293.3	1389	304.8	1410	316.8	1429	328.7		
78000	4616	1280	248.9	1301	259.3	1322	270.1	1343	281.3	1363	292.9	1383	304.5	1404	316.5	1423	328.4				
80000	4734	1297	260.8	1317	271.1	1338	281.9	1358	293.1	1379	304.6	1399	316.5	1418	328.4	1438	340.7				
81000	4793	1305	266.7	1326	277.3	1346	288.1	1366	299.2	1387	310.7	1406	322.5	1426	334.6						
84000	4971	1332	285.6	1352	296.5	1371	307.5	1391	318.5	1410	329.9	1430	341.7								

Power rating (BHP) does not include drive losses. Performance ratings do not include the effects of appurtenances in the airstream. Performance shown is for installation type B - Free inlet, Ducted outlet.

Wheel Diameter = 60.00 in.
 Outlet Area = 20.66 sq. ft. inside
 Maximum BHP = 201. X (RPM/1000)³
 Tip Speed, fpm = 15.7 x RPM

Class IVHD 1216

Size

6000 SISW

Design 5020 Backward Inclined Fan

Volume O.Vel		13"SP		14"SP		15"SP		16"SP		17"SP		18"SP		19"SP		20"SP		21"SP		22"SP	
CFM	FPM	RPM	BHP	RPM	BHP	RPM	BHP	RPM	BHP	RPM	BHP	RPM	BHP	RPM	BHP	RPM	BHP	RPM	BHP	RPM	BHP
68000	3290	981	172.8	1006	184.4	1030	196.3	1053	208.1	1076	220.2	1099	232.4	1121	244.5						
69000	3338	986	176.1	1011	187.7	1034	199.5	1058	211.6	1081	224.0	1103	236.0	1125	248.5	1146	260.8				
70000	3386	991	179.3	1015	191.0	1039	202.9	1062	215.3	1085	227.4	1107	239.8	1129	252.3	1150	264.8				
71000	3435	996	182.7	1020	194.4	1044	206.6	1067	218.7	1089	231.1	1112	243.8	1133	256.1	1155	269.0	1175	281.6		
72000	3483	1001	186.2	1025	198.0	1048	210.0	1071	222.3	1094	235.0	1116	247.4	1137	260.2	1158	273.0	1179	285.8		
73000	3532	1007	189.8	1030	201.5	1053	213.6	1076	226.1	1098	238.6	1120	251.3	1142	264.4	1162	277.0	1184	290.3	1203	303.1
74000	3580	1012	193.3	1035	205.1	1058	217.4	1080	229.8	1102	242.3	1124	255.4	1146	268.2	1167	281.3	1187	294.4	1208	307.6
75000	3628	1017	197.0	1040	209.0	1063	221.1	1085	233.5	1107	246.3	1129	259.3	1150	272.3	1171	285.7	1191	298.6	1212	312.3
76000	3677	1023	200.9	1045	212.8	1068	224.9	1090	237.5	1112	250.4	1133	263.2	1155	276.6	1175	289.7	1196	303.2	1216	316.5
77000	3725	1028	204.7	1050	216.6	1073	228.9	1095	241.6	1116	254.3	1138	267.4	1159	280.7	1179	294.0	1200	307.7		
78000	3774	1033	208.5	1056	220.6	1078	233.1	1099	245.5	1121	258.4	1143	271.7	1163	284.8	1184	298.5	1204	312.0		
79000	3822	1039	212.5	1061	224.8	1083	237.1	1104	249.7	1126	262.7	1147	275.8	1168	289.2	1188	302.9	1208	316.5		
80000	3870	1045	216.6	1067	228.9	1088	241.2	1110	254.0	1131	266.9	1152	280.1	1173	293.8	1193	307.2	1213	321.3		
82000	3967	1056	224.9	1078	237.3	1099	250.1	1120	262.7	1141	275.7	1161	289.2	1182	302.5	1202	316.6				
84000	4064	1068	233.7	1089	246.2	1110	258.8	1131	271.9	1151	285.0	1171	298.3	1191	312.2	1211	325.8				
86000	4161	1079	242.8	1100	255.2	1121	268.3	1141	281.2	1162	294.5	1182	308.1	1201	321.7						
88000	4257	1091	252.4	1112	264.9	1132	277.7	1152	291.0	1172	304.5	1192	318.0	1212	332.1						
90000	4354	1104	262.5	1124	274.8	1144	287.8	1164	301.1	1183	314.6	1203	328.6								
92000	4451	1116	273.0	1136	285.4	1156	298.2	1175	311.5	1195	325.4	1213	339.1								
94000	4548	1129	284.1	1148	296.4	1168	309.1	1187	322.5	1206	336.1										
96000	4644	1142	295.2	1161	307.9	1180	320.6	1199	333.8												
98000	4741	1155	306.9	1174	319.8	1192	332.5	1211	345.7												
100000	4838	1168	318.8	1186	331.9	1205	345.1														
102000	4935	1181	330.5	1199	344.5																
104000	5031	1195	342.8	1213	357.3																

Power rating (BHP) does not include drive losses. Performance ratings do not include the effects of appurtenances in the airstream. Performance shown is for installation type B - Free inlet, Ducted outlet. Belt drive above 350 HP not recommended.



Wheel Diameter = 66.00 in.
 Outlet Area = 25.01 sq. ft. inside
 Maximum BHP = 324. x (RPM/1000)³
 Tip Speed, fpm = 17.3 x RPM

Size

6600 sisw

Class IVHD 1106

Design 5020 Backward Inclined Fan

Volume Q.Vel		13"SP		14"SP		15"SP		16"SP		17"SP		18"SP		19"SP		20"SP		21"SP		22"SP	
CFM	FPM	RPM	BHP	RPM	BHP	RPM	BHP	RPM	BHP	RPM	BHP	RPM	BHP	RPM	BHP	RPM	BHP	RPM	BHP	RPM	BHP
83000	3319	895	211.4	917	225.6	939	239.8	960	254.3	981	269.2	1001	283.8	1021	298.7						
84000	3358	899	214.8	921	228.8	942	243.1	963	257.9	984	272.7	1004	287.4	1024	302.8	1044	317.6				
85000	3398	902	218.0	924	232.1	946	246.6	967	261.5	987	276.2	1007	291.4	1027	306.4	1047	321.6				
86000	3438	906	221.3	928	235.6	949	250.3	970	264.9	990	279.9	1011	295.3	1030	310.3	1050	325.9	1069	341.1		
87000	3478	910	224.9	932	239.2	952	253.6	973	268.5	994	283.8	1014	298.9	1033	314.3	1053	329.9	1072	345.3		
88000	3518	914	228.5	935	242.6	956	257.2	977	272.3	997	287.5	1017	302.7	1037	318.6	1056	333.8	1075	349.8	1093	365.3
89000	3558	918	232.0	939	246.2	960	260.9	980	276.1	1000	291.2	1020	306.8	1040	322.4	1059	338.0	1078	354.0	1096	369.7
90000	3598	922	235.6	943	250.0	963	264.8	984	279.7	1004	295.0	1024	310.9	1043	326.3	1062	342.4	1081	358.1	1099	374.4
92000	3678	930	243.2	950	257.6	971	272.3	991	287.5	1011	303.1	1030	318.6	1050	334.8	1068	350.7	1087	367.0	1105	383.1
94000	3758	938	250.8	958	265.4	978	280.4	998	295.6	1018	311.0	1037	327.1	1056	343.0	1075	359.5	1093	375.8		
96000	3838	946	258.8	966	273.7	986	288.6	1006	303.8	1025	319.7	1044	335.4	1063	351.8	1082	368.2	1100	384.9		
98000	3918	955	267.0	974	281.9	994	297.1	1014	312.6	1032	328.2	1051	344.3	1070	360.6	1088	377.2				
100000	3998	963	275.5	983	290.6	1002	305.9	1021	321.4	1040	337.3	1059	353.3	1077	369.7	1095	386.6				
102000	4078	972	284.4	991	299.4	1010	314.8	1029	330.7	1048	346.5	1066	362.7	1084	379.4	1102	396.0				
104000	4158	981	293.5	1000	308.6	1019	324.3	1037	340.0	1056	356.1	1074	372.6	1092	388.9						
106000	4238	990	303.0	1009	318.2	1027	333.7	1046	349.7	1064	366.2	1082	382.3	1099	399.2						
108000	4318	999	313.0	1018	328.0	1036	343.6	1054	359.9	1072	376.0	1090	392.8								
110000	4398	1008	323.3	1027	338.3	1045	354.0	1063	369.9	1080	386.5	1098	403.3								
112000	4478	1018	334.1	1036	349.0	1054	364.5	1071	380.6	1089	397.3	1106	414.0								
114000	4558	1027	345.2	1045	360.1	1063	375.5	1080	391.7	1097	408.1										
116000	4638	1037	356.3	1054	371.6	1072	387.0	1089	403.0												
118000	4718	1047	367.9	1064	383.6	1081	398.8	1098	414.8												
120000	4798	1057	379.9	1074	395.4	1090	411.2														
122000	4878	1067	391.5	1083	407.8	1100	424.0														
124000	4958	1077	403.4	1093	420.6																

Power rating (BHP) does not include drive losses.

Performance ratings do not include the effects of appurtenances in the airstream.
 Belt drive above 350 HP not recommended.

Performance shown is for installation type B - Free inlet, Ducted outlet.

Northern Blower Inc. certifies that the product shown herein is licensed to bear the AMCA Seal. Fan Sound Ratings are based on tests and procedures in accordance with AMCA Publication 211 and AMCA Publication 311, and comply with the requirements of the AMCA Certified Ratings Program.

Fan sound data testing was conducted according to AMCA Standard 300 in an AMCA Registered Laboratory. The Certified Sound Ratings Seal provides increased assurance that the published sound ratings are both reliable and accurate.

Sound data was obtained in accordance with AMCA Standard 300, Reverberant Room Method for Sound Testing of Fans, published in accordance with AMCA Standard 301, Methods for Calculating Fan Sound Ratings from Laboratory Test data.

Upon request Northern Blower will provide Sound Level Ratings for any fan selection from this catalogue. Refer also to the Northern Blower Sound Bulletin.

Fan Geometry

Designations for Rotation and Discharge of Centrifugal Fans

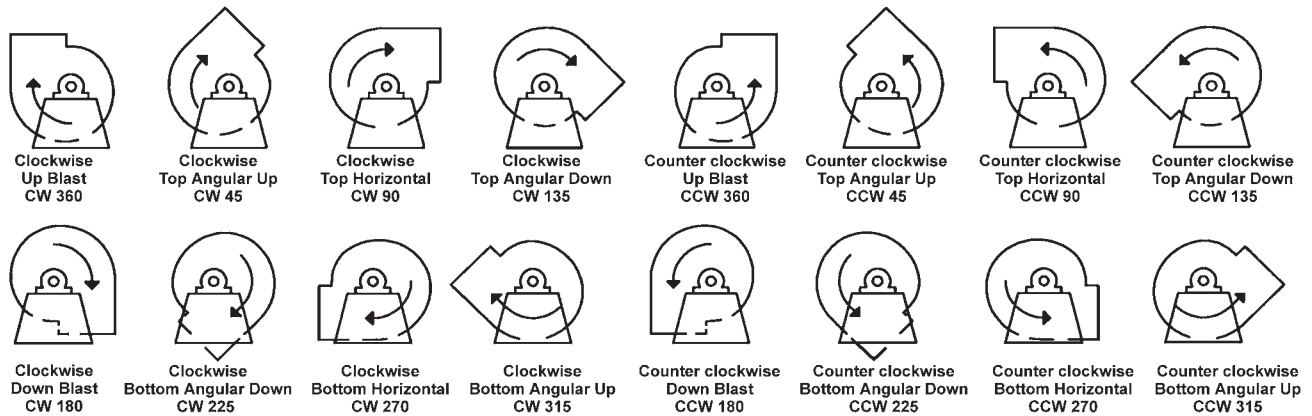

Notes:

- 1) Direction of rotation is determined from the drive side of the fan.
- 2) On single inlet fans, the drive side is always considered as the side opposite the fan inlet.
- 3) On double inlet fans with drives on both sides, the drive side is that with the higher powered drive unit.
- 4) Direction of discharge is determined in accordance with the diagrams. Angle of discharge is referred to the vertical axis of the fan and designated in degrees from such standard reference axis. Angle of discharge may be any intermediate angle as required.
- 5) For a fan inverted for ceiling suspension, or side wall mounting, the direction of rotation and discharge is determined when the fan is resting on the floor.

Reprinted by permission of the Air Movement & Control Association, Inc., 30 West University Drive, Arlington Heights, IL, 60004-1893, U.S.A.

SW - Single Width
SI - Single Inlet

DW - Double Width
DI - Double Inlet

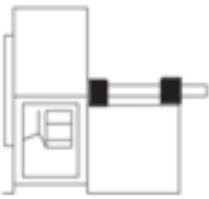

1 SWSI

For belt drive or direct connection. Impeller overhung. Two bearings on base.

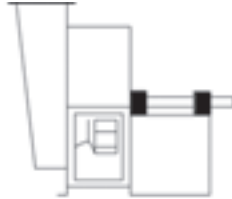

1 SWSI c/w BOX

For belt drive or direct connection. Impeller overhung. Two bearings on base. Inlet box may be self-supporting.

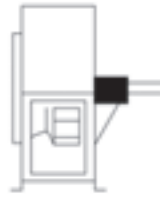

2 SWSI

For belt drive or direct connection. Impeller overhung. Bearings in bracket supported by fan housing.

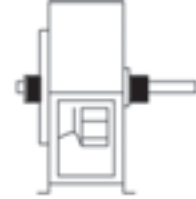

3 SWSI

For belt drive or direct connection. One bearing on each side and supported by fan housing.



3 SWSI c/w BOX

For belt drive or direct connection. One bearing on each side and supported by fan housing and inlet box. Shaft extending through inlet box.



3 SWSI c/w IND. PED.

For belt drive or direct connection. Housing is self-supporting. One bearing on each side supported by independent pedestals.

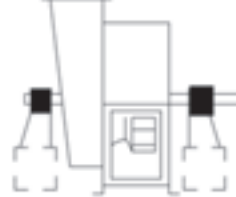

3 SWSI c/w BOX & IND. PED.

For belt drive or direct connection. Housing is self-supporting. One bearing on each side and supported by independent pedestals with shaft extending through inlet box.

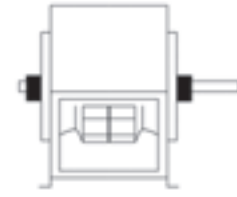

3 DWDI

For belt drive or direct connection. One bearing on each side and supported by fan housing.



3 DWDI c/w BOXES

For belt drive or direct connection. One bearing on each side and supported by inlet boxes. Shaft extending through inlet boxes.



3 DWDI c/w IND. PED.

For belt drive or direct connection. Housing is self-supporting. One bearing on each side and supported by independent pedestals.



3 DWDI c/w BOXES & IND. PED.

For belt drive or direct connection. Housing is self-supporting. One bearing on each side supported by independent pedestals with shaft extending through inlet box.

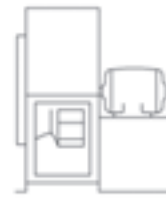

4 SWSI

For direct drive. Impeller overhung on prime mover shaft. No bearings on fan. Prime mover base mounted or integrally directly connected.

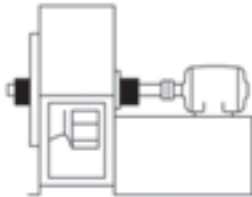

7 SWSI

For belt drive or direct connection. Arrangement 3 plus base for prime mover.

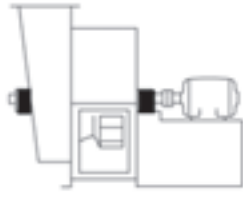

7 SWSI c/w BOX

For belt drive or direct connection. Arrangement 3 plus base for prime mover. Shaft extending through inlet box.

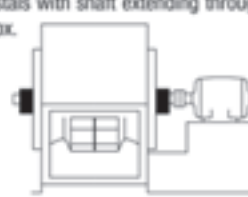

7 DWDI

For belt drive or direct connection. Arrangement 3 plus base for prime mover.

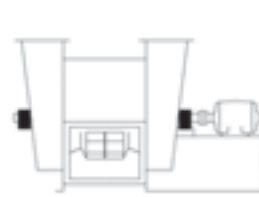

7 DWDI c/w BOXES

For belt drive or direct connection. Arrangement 3 plus base for prime mover. Shaft extending through inlet box.

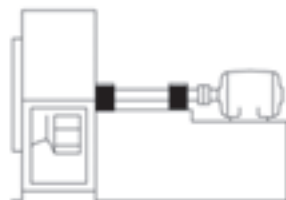

8 SWSI

For belt drive or direct connection. Arrangement 1 plus extended base for prime mover.

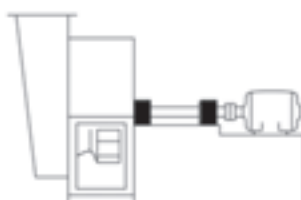

8 SWSI c/w BOX

For belt drive or direct connection. Arrangement 1 plus extended base for prime mover.

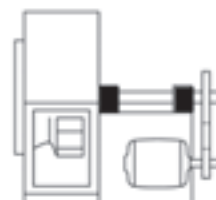

9 SWSI

For belt drive. Impeller overhung, two bearings, with prime mover outside base.

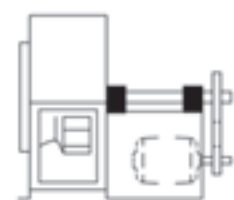

10 SWSI

For belt drive. Impeller overhung, two bearings, with prime mover inside base.



Northern Blower Inc.
901 Regent Avenue West
Winnipeg, Manitoba
Canada R2C 2Z8
☎ 204.222.4216
☎ 204.222.7601
☎ info@northernblower.com
🌐 www.northernblower.com