

Series 5000 DIDW Centrifugal BI Fan

Design 5020 DW • Class I, II, & III



Series 5000 Centrifugal BI Fans

The Design 5020 DW BI fan is a quiet, highly efficient, and stable operating fan suited for a broad range of industrial and commercial applications.

Industrial supply and exhaust:

Fume Exhaust

Light Dust Collection

Spray Booth Exhaust

Pulp and Paper Machines

Grain Drying

Drying Kilns

Design Features	2
General Information	3
Accessories	4
Selection	6
Performance Data	7
Dimensions	20
Sound Data	22
Fan Geometry	22
Centrifugal Fan Arrangements	23

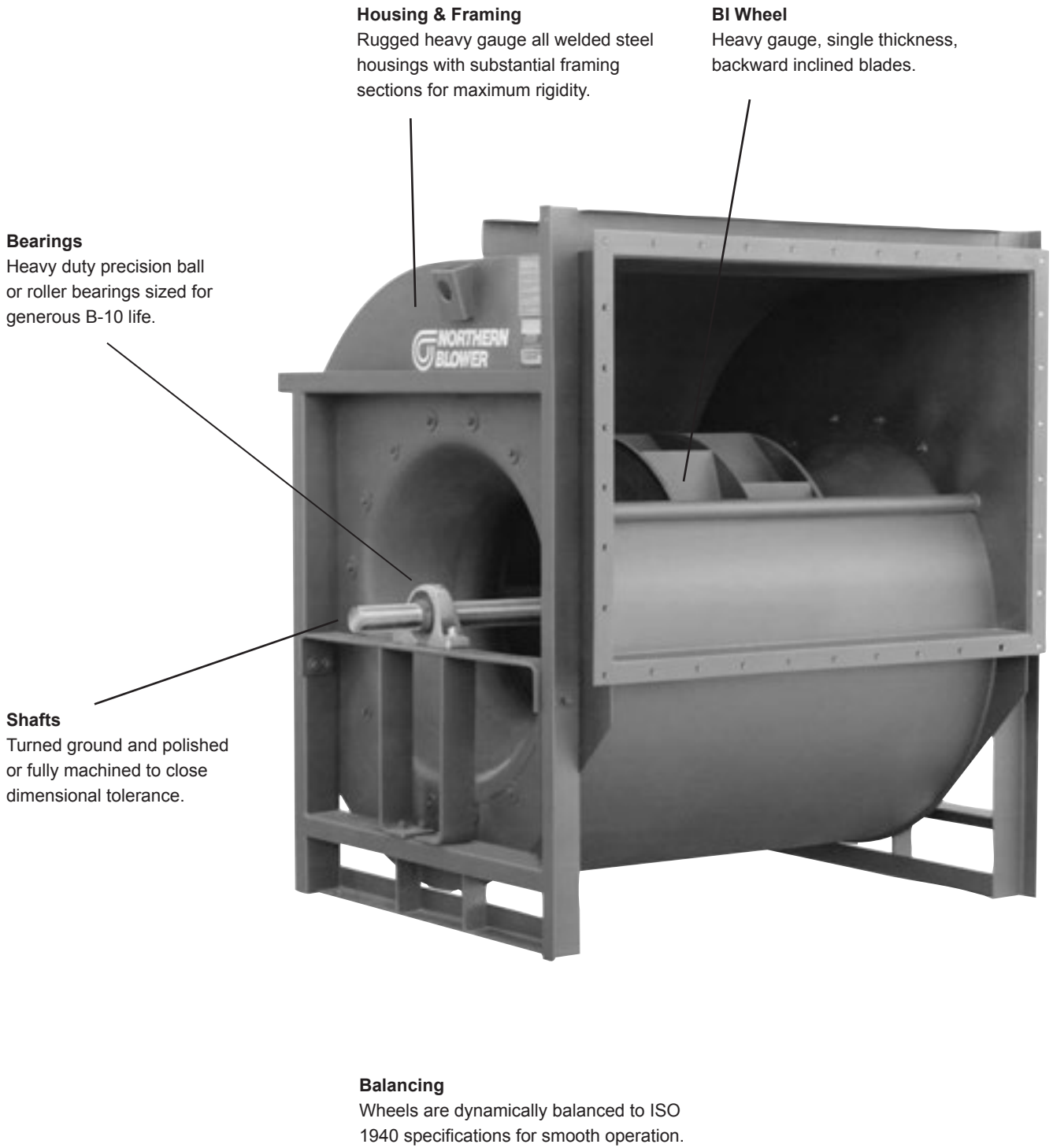

Shafts and Bearings

Shafts

Selected to have suitable strength and operated well below the first critical speed for each maximum class condition.

Bearings

Antifriction, grease lubricated, self aligning ball or roller types, solid or split housing, manufactured to internationally adopted standards by companies having worldwide acceptance and support services. Bearings are selected for continuous belt driven operation with a generous bearing life throughout each full class range.

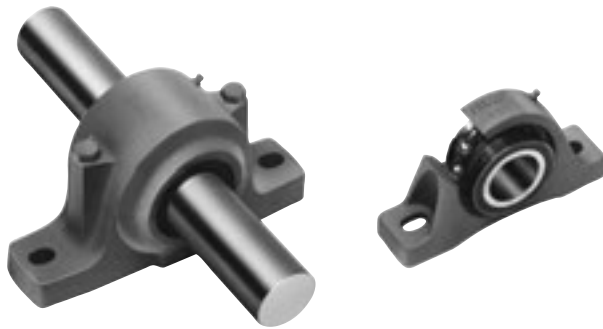

Classes of Construction

Arrangement	Fan Size Range	
	Class I & II	Class III
A/3 - DIDW	2450 - 8075	2450 - 6600

Capacities

5000 CFM to 270,000 CFM

Pressures

Class I to 7" S.P. (Size 2450 - 8075)
 Class II to 11" S.P. (Size 2450 - 8075)
 Class III to 16" S.P. (Size 2450 - 6600)

Temperatures

Operating Temperatures to 150°F
 See Table, Page 6

Design 5020 Centrifugal BI Wheel

The Northern Blower BI wheel is ruggedly designed for high operating efficiency. The blades are formed from heavy gauge single thickness sheets. Continuously welded steel construction is standard. Available from 24-1/2" to 80-3/4" diameters.



Variable Inlet Vanes

Variable Inlet Vanes provide accurate volume control with minimal reduction in performance efficiency. Fan performance remains stable through fully open to fully closed positions. Available for both manual and automatic operation to temperatures of 150° F. Vanes are connected to operate in unison.



Outlet Damper

Outlet Dampers are the least expensive air volume control device but are less efficient than Variable Inlet Vanes or Inlet Box with Inlet Damper. Northern Blower Outlet Dampers have punched flanges on both ends to allow for convenient fan and duct connections.



Inlet Boxes

Inlet Boxes provides smooth aerodynamic airflow into the fan inlet. The box is designed as an integral part of the fan housing. Inlet Dampers also are available in conjunction with the Inlet Box for efficient air volume control. Dampers are connected to operate in unison.

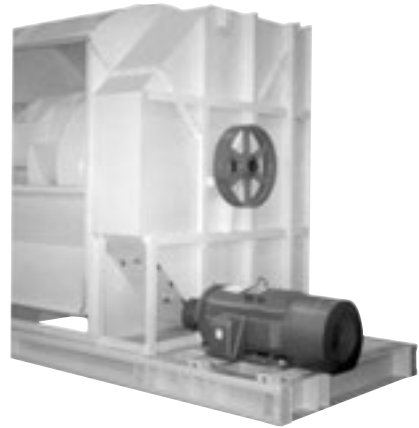

Raised Access Door

Access door raised 6" beyond scroll surface to provide room for insulation on exterior of fan housing. Insulated door plug surface is flush with inside of housing scroll.



Flush Access Door

Access door mounted flush to the fan scroll and secured with bolted clips. Quick release handle system also available.



Inlet Screens

Steel screens mounted to the inlet cone.

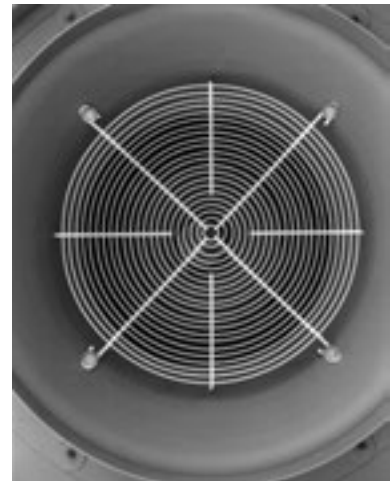

Belt Guard

Enclosed on all sides for safe operation. Tachometer holes, hinged cover, and safety colour coatings also available.



Flanged Outlet

Punched flange outlet to facilitate the bolting of duct connections to the fan outlet. Flanged Outlet needed when the fan is to be fitted with an Outlet Damper.



Vibration Isolation Base

Rigid steel frame to provide a common mounting platform for fan and motor. May be ordered with spring or rubber-in-shear isolators and motor slide base.



Additional Accessories

- Protective Coatings
- Split Housings
- Special Metals
- Drain Openings
- Extended Grease Fittings
- Split Pillow Block Bearings
- Mounted Drive Package

Fan Selection at Elevated Temperature and Altitude

Fan Selection Table

Ratings shown in the Performance Tables are based on standard air density of .075 pounds per cubic foot at the fan inlet. Standard air is dry air at 70°F and 29.92" Hg barometric pressure. When air density varies from standard, due to temperature or altitude changes, the Air Density Correction Factor from the Table is applied. Refer to the sample selection that follows.

Note that data in the selection tables does not include the effects of accessories such as inlet dampers, outlet dampers, screens, or other components in the air stream.

Air Density Correction Factor							
Air Temp °F	Elevation (feet) above Sea Level						
	0	500	1000	2000	3000	4000	5000
-40°	.79	.81	.82	.85	.88	.92	.95
0	.87	.88	.90	.93	.97	1.00	1.04
40°	.94	.96	.98	1.01	1.05	1.09	1.13
70°	1.00	1.00	1.04	1.08	1.12	1.16	1.20
100°	1.06	1.08	1.10	1.14	1.18	1.22	1.27
150°	1.15	1.17	1.19	1.24	1.28	1.33	1.38

Sample Selection of a Belt Drive Fan

Select a fan for the operating conditions of 15000 CFM at 1-1/4" SP, 70°F and 5000 feet elevation.

- 1) Multiply the Operating SP by the Air Density Correction Factor to obtain Equivalent SP:

$$\begin{aligned} \text{Equivalent SP} &= \text{Operating SP} \times \text{Air Density Corr. Factor} \\ &= 1\text{-}1/4" \times 1.20 = 1\text{-}1/2" \end{aligned}$$

- 2) From the Performance Table, select the fan size.
For 15000 CFM at 1-1/2" SP an efficient selection would be a size 2700 fan. Interpolating from the Performance Table given on page 8, the selection fan performance is 973 RPM and 6.8 BHP at standard temperature and pressure.

- 3) Divide the Equivalent BHP by the Air Density Correction Factor to obtain the Operating BHP:

$$\begin{aligned} \text{Operating BHP} &= \frac{\text{Equivalent BHP}}{\text{Air Density Correction Factor}} \\ &= \frac{6.8}{1.20} = 5.67 \text{ BHP} \end{aligned}$$

Wheel Diameter = 24.50 in.
 Outlet Area = 6.21 sq. ft. inside
 Maximum BHP = 4.52 x (RPM/1000)³
 Tip Speed, fpm = 6.41 x RPM

Size

2450 DIDW

Design 5020 Centrifugal BI Fans

Class I RPM 1672
 Class II RPM 2177
 Class III RPM 2740

Volume		1/4"SP		3/8"SP		1/2"SP		5/8"SP		3/4"SP		7/8"SP		1"SP		1-1/4"SP		1-1/2"SP		1-3/4"SP	
CFM	FPM	RPM	BHP	RPM	BHP	RPM	BHP	RPM	BHP	RPM	BHP	RPM	BHP	RPM	BHP	RPM	BHP	RPM	BHP	RPM	BHP
5000	805	436	0.37	478	0.48	516	0.58	550	0.70	582	0.81	614	0.94	645	1.06						
6000	966	494	0.54	527	0.66	562	0.78	596	0.91	627	1.04	655	1.17	681	1.31	734	1.60	787	1.91		
7000	1127	555	0.76	584	0.89	613	1.03	643	1.18	672	1.32	701	1.47	727	1.63	775	1.94	820	2.27	865	2.61
8000	1288	619	1.04	644	1.19	669	1.35	694	1.51	720	1.67	747	1.84	772	2.00	820	2.35	863	2.70	904	3.07
9000	1449	684	1.39	707	1.56	729	1.73	751	1.91	774	2.09	796	2.27	820	2.45	866	2.83	910	3.22	949	3.61
10000	1610	750	1.82	771	2.01	791	2.19	811	2.38	831	2.58	851	2.78	872	2.98	913	3.39	955	3.81	995	4.23
11000	1771	817	2.34	836	2.54	855	2.75	873	2.95	891	3.16	909	3.38	928	3.60	965	4.04	1003	4.49	1041	4.95
12000	1932	885	2.96	903	3.18	920	3.40	937	3.62	953	3.84	970	4.07	987	4.31	1020	4.78	1054	5.26	1089	5.76
13000	2093	953	3.68	969	3.91	985	4.15	1001	4.39	1017	4.63	1032	4.88	1047	5.13	1078	5.63	1109	6.14	1140	6.67
14000	2254	1021	4.52	1037	4.77	1052	5.02	1066	5.28	1081	5.53	1095	5.80	1110	6.06	1138	6.59	1166	7.14	1195	7.69
15000	2415	1090	5.47	1105	5.75	1118	6.01	1132	6.29	1146	6.56	1160	6.84	1173	7.12	1200	7.69	1226	8.26	1253	8.85
16000	2576	1159	6.57	1173	6.85	1186	7.14	1199	7.43	1212	7.72	1225	8.01	1237	8.31	1262	8.91	1287	9.52	1312	10.13
17000	2738	1228	7.80	1241	8.10	1254	8.41	1266	8.71	1278	9.02	1290	9.33	1302	9.64	1326	10.27	1349	10.91	1373	11.56
18000	2899	1297	9.18	1309	9.50	1322	9.82	1333	10.14	1345	10.47	1356	10.80	1368	11.12	1390	11.78	1413	12.46	1435	13.13
19000	3060	1367	10.72	1378	11.06	1390	11.40	1401	11.74	1412	12.07	1423	12.42	1434	12.76	1455	13.46	1477	14.16	1498	14.87
20000	3221	1436	12.43	1447	12.78	1458	13.13	1469	13.50	1480	13.85	1490	14.21	1500	14.58	1521	15.30	1541	16.03	1561	16.77
21000	3382	1506	14.31	1516	14.69	1527	15.05	1537	15.43	1547	15.81	1557	16.18	1567	16.55	1587	17.32	1606	18.08	1625	18.85
22000	3543	1575	16.37	1586	16.77	1596	17.15	1605	17.55	1615	17.95	1625	18.34	1634	18.72	1653	19.53	1672	20.31	1690	21.13
23000	3704	1645	18.63	1655	19.05	1665	19.45	1674	19.86	1684	20.27	1693	20.69	1702	21.09	1720	21.92	1738	22.75	1756	23.58
24000	3865	1715	21.09	1724	21.52	1734	21.95	1743	22.37	1752	22.80	1761	23.24	1770	23.67	1787	24.51	1804	25.39	1821	26.24
25000	4026	1785	23.76	1794	24.21	1803	24.67	1812	25.10	1820	25.54	1829	25.99	1838	26.45	1854	27.32	1871	28.23	1887	29.12
26000	4187	1855	26.66	1864	27.12	1872	27.59	1881	28.05	1889	28.51	1898	28.97	1906	29.44	1922	30.36	1938	31.28	1954	32.24
28000	4509	1995	33.14	2003	33.63	2011	34.14	2019	34.65	2027	35.13	2035	35.62	2043	36.12	2058	37.14	2073	38.12	2087	39.11
Volume		2"SP		2-1/2"SP		3"SP		3-1/2"SP		4"SP		4-1/2"SP		5"SP		5-1/2"SP		6"SP		6-1/2"SP	
CFM	FPM	RPM	BHP	RPM	BHP	RPM	BHP	RPM	BHP	RPM	BHP	RPM	BHP	RPM	BHP	RPM	BHP	RPM	BHP	RPM	BHP
7000	1127	911	2.98																		
8000	1288	943	3.45	1022	4.25	1100	5.11														
9000	1449	986	4.01	1056	4.86	1127	5.75	1197	6.68												
10000	1610	1032	4.66	1099	5.56	1162	6.49	1226	7.46	1289	8.48	1352	9.56								
11000	1771	1078	5.41	1145	6.36	1206	7.34	1263	8.36	1321	9.42	1378	10.52	1436	11.66	1492	12.84				
12000	1932	1124	6.25	1191	7.26	1252	8.30	1307	9.37	1361	10.48	1413	11.61	1465	12.79	1518	14.00	1571	15.25	1623	16.55
13000	2093	1172	7.20	1237	8.28	1297	9.38	1353	10.51	1405	11.65	1454	12.83	1503	14.05	1551	15.30	1600	16.58	1648	17.90
14000	2254	1224	8.26	1284	9.40	1343	10.57	1399	11.76	1451	12.97	1500	14.20	1546	15.46	1591	16.76	1636	18.08	1680	19.43
15000	2415	1279	9.44	1334	10.65	1390	11.89	1445	13.14	1497	14.41	1546	15.70	1591	17.01	1635	18.35	1677	19.71	1719	21.11
16000	2576	1337	10.75	1387	12.03	1439	13.33	1491	14.65	1542	15.98	1591	17.34	1637	18.70	1680	20.09	1722	21.51	1763	22.96
17000	2738	1396	12.22	1443	13.54	1490	14.91	1539	16.30	1588	17.70	1637	19.12	1683	20.55	1727	22.00	1768	23.47	1808	24.97
18000	2899	1457	13.82	1501	15.21	1545	16.65	1590	18.09	1636	19.56	1683	21.04	1728	22.54	1772	24.06	1814	25.60	1854	27.14
19000	3060	1518	15.59	1560	17.05	1602	18.53	1644	20.04	1687	21.57	1731	23.13	1775	24.69	1818	26.28	1860	27.88	1900	29.48
20000	3221	1581	17.52	1620	19.04	1660	20.58	1699	22.16	1740	23.75	1781	25.37	1822	27.00	1864	28.65	1905	30.32	1945	31.99
21000	3382	1645	19.64	1682	21.22	1720	22.83	1757	24.46	1795	26.11	1833	27.79	1872	29.48	1912	31.20	1952	32.93	1991	34.68
22000	3543	1708	21.93	1744	23.57	1780	25.24	1816	26.93	1852	28.66	1888	30.41	1925	32.15	1962	33.92	2000	35.72	2038	37.54
23000	3704	1773	24.43	1808	26.14	1842	27.87	1876	29.61	1910	31.39	1944	33.19	1979	35.02	2014	36.85	2050	38.70	2086	40.58
24000	3865	1838	27.13	1871	28.89	1904	30.67	1937	32.49	1969	34.35	2002	36.19	2035	38.06	2068	39.98	2102	41.89	2136	43.81
25000	4026	1903	30.03	1935	31.85	1967	33.72	1999	35.60	2030	37.48	2061	39.40	2092	41.36	2124	43.30	2156	45.29	2188	47.28
26000	4187	1969	33.15	2000	35.06	2031	36.97	2061	38.89	2091	40.86	2121	42.84	2151	44.83	2181	46.88	2211	48.89	2242	50.95
28000	4509	2102	40.13	2131	42.13	2159	44.17	2188	46.24	2215	48.30	2243	50.43	2271	52.52	2299	54.68	2326	56.81	2354	59.00
30000	4831	2236	48.06	2263	50.21	2290	52.37	2316	54.55	2342	56.76	2368	58.96	2394	61.22	2420	63.45	2445	65.74	2471	68.02
Volume		7"SP		8"SP		9"SP		10"SP		11"SP		12"SP		13"SP		14"SP		15"SP		16"SP	
CFM	FPM	RPM	BHP	RPM	BHP	RPM	BHP	RPM	BHP	RPM	BHP	RPM	BHP	RPM	BHP	RPM	BHP	RPM	BHP	RPM	BHP
13000	2093	1697	19.26	1791	22.05																
14000	2254	1725	20.81	1816	23.69	1904	26.67														
15000	2415	1761	22.55	1845	25.46	1929	28.52	2012	31.70												
16000	2576	1802	24.42	1880	27.44	1959	30.55	2037	33.78	2115	37.12	2191	40.56								
17000	2738	1846	26.47	1921	29.59	1994	32.79	2068	36.08	2142	39.49	2216	43.00	2289	46.64						
18000	2899	1892	28.69	1965	31.90	2035	35.20	2104	38.58	2174	42.06	2244	45.63	2313	49.28	2382	53.02	2449	56.89		
19000	3060	1938	31.09	2010	34.40	2079	37.79	2145	41.25	2210	44.80	2276	48.43	2342	52.16	2408	55.98	2474	59.92	2538	63.95
20000	3221	1984	33.66	2057	37.09	2125	40.58	2189	44.14	2252	47.76	2313	51.47	2375	55.26	2438	59.16	2501	63.19	2563	67.23
21000	3382	2029	36.41	2103	39.96	2171	43.56	2234	47.21	2296	50.94	2355	54.73	2414	58.59	2473	62.57	2533	66.67	2592	70.76
22000	3543	2075	39.34	2148	43.03	2216	46.72	2280	50.48	2341	54.32	2399	58.22	2456	62.15	2512	66.19	2569	70.37	2625	74.54
23000	3704	2122	42.47	2193	46.26	2261	50.08	2326	53.96	2386	57.90	2445	61.92	2500	65.96	2554	70.06	2608			

Wheel Diameter = 27.00 in.
 Outlet Area = 7.54 sq. ft. inside
 Maximum BHP = 7.35 x (RPM/1000)³
 Tip Speed, fpm = 7.07 x RPM

Size

2700 DIDW

Design 5020 Centrifugal BI Fans

Class I RPM 1517
 Class II RPM 1975
 Class III RPM 2486

Volume O.Vel		1/4"SP		3/8"SP		1/2"SP		5/8"SP		3/4"SP		7/8"SP		1"SP		1-1/4"SP		1-1/2"SP		1-3/4"SP	
CFM	FPM	RPM	BHP	RPM	BHP	RPM	BHP	RPM	BHP	RPM	BHP	RPM	BHP	RPM	BHP	RPM	BHP	RPM	BHP	RPM	BHP
6000	796	393	0.4	431	0.6	466	0.7	497	0.8	526	1.0	555	1.1	584	1.3						
7000	928	435	0.6	467	0.7	500	0.9	531	1.0	559	1.2	584	1.4	609	1.5	659	1.9	709	2.2		
8000	1061	480	0.8	508	1.0	536	1.1	565	1.3	593	1.5	619	1.6	642	1.8	686	2.2	730	2.6	774	3.0
9000	1193	527	1.1	552	1.2	576	1.4	602	1.6	628	1.8	653	2.0	677	2.2	720	2.5	759	3.0	798	3.4
10000	1326	575	1.4	598	1.5	620	1.7	642	1.9	664	2.1	688	2.3	711	2.6	754	3.0	793	3.4	829	3.9
11000	1458	624	1.7	645	1.9	665	2.1	685	2.3	705	2.6	725	2.8	746	3.0	788	3.5	828	3.9	863	4.4
12000	1591	674	2.1	693	2.4	711	2.6	729	2.8	748	3.1	766	3.3	785	3.5	823	4.0	862	4.5	898	5.0
13000	1724	724	2.6	741	2.9	759	3.1	776	3.4	792	3.6	809	3.9	826	4.1	861	4.7	897	5.2	932	5.7
14000	1856	774	3.2	791	3.5	807	3.7	823	4.0	838	4.3	854	4.5	870	4.8	901	5.4	934	5.9	967	6.5
15000	1989	825	3.9	840	4.2	855	4.4	870	4.7	885	5.0	900	5.3	914	5.6	944	6.2	973	6.8	1004	7.4
16000	2121	876	4.6	890	4.9	905	5.2	919	5.5	933	5.8	946	6.1	960	6.4	988	7.0	1015	7.7	1043	8.3
17000	2254	927	5.5	941	5.8	954	6.1	968	6.4	981	6.7	994	7.0	1007	7.4	1033	8.0	1058	8.7	1084	9.3
18000	2387	978	6.4	991	6.8	1004	7.1	1017	7.4	1029	7.7	1042	8.1	1054	8.4	1079	9.1	1103	9.8	1127	10.5
19000	2519	1029	7.5	1042	7.8	1054	8.2	1066	8.5	1078	8.9	1090	9.2	1102	9.6	1125	10.3	1148	11.0	1171	11.7
20000	2652	1081	8.7	1093	9.0	1105	9.4	1116	9.7	1128	10.1	1139	10.5	1150	10.8	1173	11.6	1194	12.3	1216	13.1
21000	2784	1133	9.9	1144	10.3	1155	10.7	1166	11.1	1177	11.5	1188	11.8	1199	12.2	1220	13.0	1241	13.8	1262	14.6
22000	2917	1184	11.4	1195	11.7	1206	12.1	1217	12.5	1227	12.9	1238	13.3	1248	13.7	1268	14.5	1289	15.4	1308	16.2
24000	3182	1288	14.6	1298	15.0	1308	15.4	1318	15.9	1328	16.3	1337	16.7	1347	17.2	1366	18.0	1384	18.9	1403	19.8
26000	3447	1392	18.4	1402	18.8	1411	19.3	1420	19.8	1429	20.2	1438	20.7	1447	21.2	1465	22.1	1482	23.0	1499	24.0
28000	3713	1496	22.8	1505	23.3	1514	23.8	1522	24.3	1531	24.8	1540	25.3	1548	25.8	1564	26.8	1580	27.8	1596	28.8
30000	3978	1601	27.9	1609	28.4	1617	28.9	1625	29.5	1633	30.0	1641	30.5	1649	31.1	1664	32.1	1680	33.2	1695	34.3
32000	4243	1705	33.7	1713	34.2	1721	34.8	1729	35.4	1736	35.9	1743	36.5	1751	37.1	1766	38.2	1780	39.4	1794	40.5
34000	4508	1810	40.2	1817	40.8	1825	41.4	1832	42.1	1839	42.6	1846	43.2	1853	43.9	1867	45.1	1881	46.3	1894	47.5
Volume O.Vel		2"SP		2-1/2"SP		3"SP		3-1/2"SP		4"SP		4-1/2"SP		5"SP		5-1/2"SP		6"SP		6-1/2"SP	
CFM	FPM	RPM	BHP	RPM	BHP	RPM	BHP	RPM	BHP	RPM	BHP	RPM	BHP	RPM	BHP	RPM	BHP	RPM	BHP	RPM	BHP
8000	1061	817	3.4																		
9000	1193	837	3.8	914	4.8																
10000	1326	864	4.3	934	5.3	1004	6.4														
11000	1458	897	4.9	961	5.9	1024	7.0	1087	8.2												
12000	1591	932	5.6	992	6.6	1051	7.8	1109	8.9	1167	10.2	1224	11.5								
13000	1724	966	6.3	1026	7.4	1082	8.6	1136	9.8	1189	11.1	1243	12.4	1296	13.8						
14000	1856	1000	7.1	1061	8.3	1116	9.5	1167	10.8	1217	12.1	1266	13.5	1316	14.9	1366	16.3	1415	17.8		
15000	1989	1035	8.0	1095	9.2	1150	10.5	1201	11.8	1248	13.2	1295	14.6	1341	16.0	1387	17.5	1434	19.1	1480	20.6
16000	2121	1072	9.0	1129	10.3	1184	11.6	1235	13.0	1282	14.4	1327	15.9	1370	17.3	1413	18.9	1457	20.5	1501	22.1
17000	2254	1111	10.0	1165	11.4	1219	12.8	1270	14.3	1317	15.8	1361	17.2	1403	18.8	1444	20.4	1484	22.0	1525	23.6
18000	2387	1152	11.2	1202	12.7	1253	14.1	1303	15.6	1351	17.2	1395	18.7	1437	20.3	1476	21.9	1515	23.6	1553	25.3
19000	2519	1194	12.5	1241	14.0	1289	15.5	1338	17.1	1385	18.7	1430	20.3	1471	22.0	1510	23.6	1548	25.3	1585	27.0
20000	2652	1238	13.9	1282	15.5	1327	17.1	1373	18.7	1419	20.4	1463	22.1	1505	23.8	1545	25.5	1582	27.2	1618	29.0
21000	2784	1283	15.4	1324	17.0	1367	18.7	1410	20.4	1454	22.1	1497	23.9	1539	25.7	1579	27.4	1617	29.2	1652	31.1
22000	2917	1328	17.0	1368	18.7	1408	20.5	1449	22.2	1490	24.0	1532	25.8	1573	27.7	1613	29.5	1651	31.4	1687	33.3
24000	3182	1421	20.7	1457	22.5	1493	24.4	1530	26.3	1567	28.2	1605	30.1	1643	32.1	1681	34.1	1719	36.1	1755	38.1
26000	3447	1516	25.0	1549	26.9	1583	28.9	1616	30.9	1649	32.9	1683	35.0	1718	37.1	1753	39.2	1789	41.4	1823	43.5
28000	3713	1612	29.8	1643	31.9	1674	34.0	1705	36.2	1736	38.3	1767	40.5	1798	42.7	1830	45.0	1862	47.2	1895	49.5
30000	3978	1709	35.4	1739	37.6	1768	39.8	1797	42.1	1825	44.4	1854	46.7	1883	49.0	1912	51.4	1941	53.7	1971	56.2
32000	4243	1808	41.7	1836	44.0	1863	46.3	1890	48.7	1917	51.1	1944	53.5	1970	56.0	1997	58.5	2024	61.0	2052	63.5
34000	4508	1907	48.7	1933	51.1	1959	53.6	1985	56.1	2010	58.6	2035	61.2	2060	63.8	2086	66.4	2111	69.0	2136	71.6
36000	4773	2007	56.5	2032	59.1	2056	61.7	2081	64.3	2105	67.0	2128	69.7	2152	72.4	2176	75.1	2200	77.8	2223	80.5
38000	5038	2108	65.3	2131	68.0	2154	70.7	2178	73.5	2200	76.2	2223	79.0	2245	81.8	2268	84.7	2290	87.5	2312	90.4
Volume O.Vel		7"SP		8"SP		9"SP		10"SP		11"SP		12"SP		13"SP		14"SP		15"SP		16"SP	
CFM	FPM	RPM	BHP	RPM	BHP	RPM	BHP	RPM	BHP	RPM	BHP	RPM	BHP	RPM	BHP	RPM	BHP	RPM	BHP	RPM	BHP
15000	1989	1525	22.3																		
16000	2121	1544	23.7	1629	27.1																
17000	2254	1566	25.3	1648	28.8	1728	32.4														
18000	2387	1592	27.0	1669	30.5	1746	34.2	1822	38.1												
19000	2519	1621	28.8	1694	32.4	1767	36.2	1840	40.1	1912	44.2										
20000	2652	1654	30.8	1723	34.5	1792	38.3	1861	42.3	1931	46.4	1999	50.6								
21000	2784	1687	32.9	1754	36.7	1820	40.6	1886	44.7	1952	48.8	2017	53.1	2082	57.5	2146	62.0				
22000	2917	1721	35.2	1787	39.1	1851	43.1	1913	47.2	1976	51.4	2039	55.8	2102	60.2	2164	64.8	2225	69.5		
24000	3182	1790	40.1	1856	44.2	1918	48.4	1976	52.7	2034	57.1	2091	61.6	2148	66.2	2205	70.9	2263	75.7	2321	80.7
26000	3447	1858	45.6	1924	50.0	1986	54.4	2044	58.9	2099	63.5	2153	68.1	2206	72.9	2258	77.8	2311	82.7	2363	87.8
28000	3713	1928	51.8	1992	56.4	2054	61.1	2113	65.8	2168	70.6	2221	75.5	2271	80.4	2320	85.4	2369	90.5	2417	95.7
30000	3978	2001	58.5	2062	63.4	2122	68.4	2181	73.4	2236	78.4	2289	83.4	2338	88.5	2387	93.8	2434	99.1	2479	104.4
32000	4243	2079	66.0	2135	71.2	2192	76.4	2248	81.6	2303	86.9	2356	92.2	2407	97.5	2456	103.0				
34000	4508	2161	74.3	2213	79.6	2266	85.1	2319	90.6	2372	96.1	2424	101.7	2475							

Wheel Diameter = 30.00 in.
 Outlet Area = 9.3 sq. ft. inside
 Maximum BHP = 12.5 x (RPM/1000)³
 Tip Speed, fpm = 7.85 x RPM

Size

3000 DIDW

Design 5020 Centrifugal BI Fans

Class I RPM 1364
 Class II RPM 1777
 Class III RPM 2236

Volume		1/4"SP		3/8"SP		1/2"SP		5/8"SP		3/4"SP		7/8"SP		1"SP		1-1/4"SP		1-1/2"SP		1-3/4"SP	
CFM	FPM	RPM	BHP	RPM	BHP	RPM	BHP	RPM	BHP	RPM	BHP	RPM	BHP	RPM	BHP	RPM	BHP	RPM	BHP	RPM	BHP
7000	752	342	0.5	378	0.6	409	0.8	437	1.0	465	1.1	493	1.3	520	1.5						
8000	859	371	0.6	403	0.8	434	1.0	462	1.1	487	1.3	511	1.5	535	1.7	584	2.1				
9000	967	403	0.8	431	1.0	459	1.2	487	1.4	512	1.6	535	1.8	557	2.0	600	2.4	643	2.9		
10000	1074	436	1.0	461	1.2	486	1.4	512	1.6	537	1.8	560	2.1	581	2.3	621	2.7	659	3.2	698	3.7
11000	1181	471	1.3	493	1.5	515	1.7	538	1.9	562	2.1	585	2.4	606	2.6	645	3.1	681	3.6	716	4.1
12000	1289	506	1.6	526	1.8	547	2.0	567	2.3	588	2.5	610	2.8	631	3.0	670	3.5	705	4.1	738	4.6
13000	1396	541	1.9	560	2.1	579	2.4	598	2.6	617	2.9	637	3.2	656	3.4	695	4.0	730	4.6	763	5.1
14000	1504	577	2.3	595	2.5	612	2.8	630	3.1	647	3.4	665	3.6	683	3.9	720	4.5	755	5.1	788	5.7
15000	1611	613	2.7	630	3.0	646	3.3	663	3.6	679	3.9	695	4.2	712	4.5	746	5.1	780	5.7	813	6.3
16000	1718	649	3.2	665	3.5	681	3.8	696	4.1	712	4.4	727	4.8	742	5.1	774	5.7	806	6.4	837	7.0
17000	1826	686	3.8	701	4.1	716	4.4	731	4.7	745	5.1	759	5.4	774	5.7	803	6.4	833	7.1	863	7.8
18000	1933	723	4.4	737	4.8	751	5.1	765	5.4	779	5.8	792	6.1	806	6.5	833	7.2	861	7.9	889	8.6
19000	2041	760	5.1	774	5.5	787	5.8	800	6.2	813	6.5	826	6.9	839	7.3	865	8.0	891	8.8	917	9.5
20000	2148	797	5.9	810	6.3	823	6.6	836	7.0	848	7.4	860	7.8	873	8.1	897	8.9	921	9.7	946	10.5
22000	2363	872	7.7	884	8.1	896	8.5	907	8.9	919	9.3	930	9.7	941	10.1	963	11.0	985	11.8	1007	12.7
24000	2578	947	9.9	958	10.3	969	10.7	980	11.2	990	11.6	1001	12.0	1011	12.5	1031	13.4	1052	14.3	1072	15.2
26000	2792	1022	12.4	1032	12.8	1043	13.3	1052	13.8	1062	14.2	1072	14.7	1082	15.2	1101	16.1	1120	17.1	1138	18.1
28000	3007	1098	15.3	1107	15.8	1117	16.3	1126	16.8	1135	17.3	1144	17.8	1153	18.3	1171	19.3	1189	20.4	1206	21.4
30000	3222	1173	18.7	1182	19.2	1191	19.7	1200	20.3	1209	20.8	1217	21.3	1226	21.9	1242	23.0	1259	24.1	1275	25.2
32000	3437	1249	22.5	1258	23.1	1266	23.6	1274	24.2	1283	24.8	1291	25.3	1299	25.9	1315	27.1	1330	28.2	1346	29.4
34000	3652	1325	26.8	1333	27.4	1341	28.0	1349	28.6	1357	29.2	1365	29.8	1372	30.4	1387	31.7	1402	32.9	1416	34.1
36000	3866	1401	31.7	1409	32.3	1417	33.0	1424	33.6	1431	34.2	1439	34.9	1446	35.5	1460	36.8	1474	38.1	1488	39.4
38000	4081	1477	37.1	1485	37.8	1492	38.5	1499	39.1	1506	39.8	1513	40.5	1520	41.2	1533	42.5	1547	43.9	1560	45.2
40000	4296	1554	43.1	1561	43.8	1567	44.5	1574	45.3	1581	45.9	1588	46.7	1594	47.4	1607	48.8	1620	50.2	1633	51.7
Volume		2"SP		2-1/2"SP		3"SP		3-1/2"SP		4"SP		4-1/2"SP		5"SP		5-1/2"SP		6"SP		6-1/2"SP	
CFM	FPM	RPM	BHP	RPM	BHP	RPM	BHP	RPM	BHP	RPM	BHP	RPM	BHP	RPM	BHP	RPM	BHP	RPM	BHP	RPM	BHP
10000	1074	737	4.3																		
11000	1181	752	4.7	821	5.9																
12000	1289	770	5.2	835	6.4	899	7.7														
13000	1396	793	5.7	853	7.0	912	8.3	971	9.7												
14000	1504	818	6.3	874	7.6	929	9.0	985	10.4	1039	11.9										
15000	1611	843	7.0	898	8.3	949	9.7	1001	11.2	1053	12.7	1104	14.3								
16000	1718	868	7.7	923	9.1	973	10.6	1021	12.1	1069	13.6	1118	15.3	1166	17.0						
17000	1826	893	8.5	948	10.0	997	11.5	1043	13.0	1089	14.6	1134	16.3	1180	18.0	1225	19.8	1269	21.6		
18000	1933	918	9.4	973	10.9	1022	12.5	1068	14.1	1111	15.7	1154	17.4	1197	19.2	1240	21.0	1283	22.9	1325	24.8
19000	2041	944	10.3	997	11.9	1047	13.5	1093	15.2	1135	16.9	1176	18.6	1217	20.4	1257	22.3	1298	24.2	1339	26.1
20000	2148	971	11.3	1023	13.0	1072	14.7	1118	16.4	1160	18.1	1200	19.9	1239	21.8	1277	23.7	1316	25.6	1354	27.6
22000	2363	1030	13.6	1076	15.3	1122	17.2	1168	19.0	1210	20.9	1250	22.8	1287	24.7	1323	26.7	1359	28.7	1393	30.8
24000	2578	1092	16.1	1133	18.0	1175	20.0	1218	22.0	1260	24.0	1300	26.0	1337	28.1	1373	30.1	1407	32.3	1440	34.4
26000	2792	1157	19.1	1194	21.1	1232	23.2	1271	25.3	1311	27.5	1350	29.6	1387	31.8	1423	34.0	1457	36.3	1489	38.5
28000	3007	1224	22.5	1258	24.6	1293	26.8	1328	29.1	1364	31.3	1400	33.6	1437	35.9	1472	38.3	1506	40.6	1539	43.0
30000	3222	1292	26.3	1324	28.6	1356	30.9	1388	33.2	1421	35.6	1455	38.1	1489	40.5	1523	43.0	1556	45.5	1589	48.0
32000	3437	1361	30.6	1391	33.0	1421	35.4	1451	37.9	1481	40.4	1512	43.0	1543	45.5	1575	48.2	1607	50.8	1639	53.4
34000	3652	1431	35.4	1459	37.9	1488	40.5	1516	43.1	1544	45.7	1573	48.4	1601	51.1	1631	53.8	1660	56.6	1690	59.3
36000	3866	1502	40.7	1529	43.4	1556	46.0	1582	48.8	1609	51.5	1635	54.3	1662	57.1	1689	60.0	1717	62.9	1745	65.7
38000	4081	1573	46.6	1599	49.4	1624	52.2	1650	55.0	1675	57.9	1700	60.8	1725	63.8	1750	66.7	1776	69.8	1802	72.7
40000	4296	1645	53.1	1670	56.0	1694	58.9	1718	61.9	1742	64.9	1766	67.9	1789	71.0	1813	74.1	1837	77.2	1861	80.3
42000	4511	1718	60.2	1741	63.2	1764	66.3	1787	69.4	1810	72.5	1833	75.7	1855	78.8	1878	82.1	1900	85.3	1923	88.5
44000	4726	1790	68.0	1813	71.1	1835	74.4	1857	77.5	1879	80.8	1900	84.0	1922	87.4	1943	90.7	1965	94.0	1986	97.4
46000	4940	1863	76.5	1885	79.8	1906	83.0	1927	86.4	1948	89.7	1969	93.1	1990	96.5	2010	100.0	2031	103.4	2051	107.0
Volume		7"SP		8"SP		9"SP		10"SP		11"SP		12"SP		13"SP		14"SP		15"SP		16"SP	
CFM	FPM	RPM	BHP	RPM	BHP	RPM	BHP	RPM	BHP	RPM	BHP	RPM	BHP	RPM	BHP	RPM	BHP	RPM	BHP	RPM	BHP
19000	2041	1379	28.1																		
20000	2148	1393	29.6																		
22000	2363	1428	32.9	1470	33.9																
24000	2578	1472	36.6	1536	41.2	1600	45.8	1664	50.7	1727	55.7	1790	60.8								
26000	2792	1520	40.8	1581	45.5	1639	50.3	1698	55.3	1758	60.5	1817	65.8	1875	71.2	1932	76.8				
28000	3007	1571	45.4	1630	50.3	1686	55.3	1740	60.5	1795	65.8	1850	71.2	1905	76.8	1959	82.5	2013	88.3	2067	94.3
30000	3222	1620	50.5	1680	55.6	1735	60.9	1788	66.2	1839	71.6	1890	77.2	1940	82.9	1991	88.7	2043	94.8	2093	100.8
32000	3437	1670	56.1	1729	61.4	1785	66.9	1837	72.4	1887	78.0	1935	83.8	1983	89.7	2031	95.7	2078	101.8	2125	108.0
34000	3652	1720	62.1	1779	67.7	1835	73.4	1887	79.2	1936	85.0	1984	91.0	2030	97.0	2075	103.2	2119	109.4	2164	115.8
36000	3866	1773	68.7	1829	74.6	1884	80.5	1937	86.5	1986	92.6	2034	98.7	2079	105.0	2122	111.3	2165	117.7	2208	124.4
38000	4081	1828	75.8	1881	81.9	1934	88.1	1986	94.4	2036	100.7	2084	107.1	2130	113.6	2172	120.1	2214	126.7		
40000	4296	1886	83.5	1935	89.9	1986	96.3	2036	102.9	2085	109.4	2133	116.1	2179							

Wheel Diameter = 33.00 in.
 Outlet Area = 11.26 sq. ft. inside
 Maximum BHP = 20.1 x (RPM/1000)³
 Tip Speed, fpm = 8.64 x RPM

Size

3300 DIDW

Design 5020 Centrifugal BI Fans

Class I RPM 1223
 Class II RPM 1592
 Class III RPM 2003

Volume		1/4"SP		3/8"SP		1/2"SP		5/8"SP		3/4"SP		7/8"SP		1"SP		1-1/4"SP		1-1/2"SP		1-3/4"SP	
CFM	FPM	RPM	BHP	RPM	BHP	RPM	BHP	RPM	BHP	RPM	BHP	RPM	BHP	RPM	BHP	RPM	BHP	RPM	BHP	RPM	BHP
9000	799	315	0.6	345	0.8	375	1.0	402	1.2	427	1.4										
10000	888	339	0.8	364	1.0	392	1.2	418	1.4	443	1.6	465	1.8	486	2.1						
11000	977	363	0.9	386	1.1	410	1.4	435	1.6	459	1.8	481	2.1	502	2.3	541	2.8				
12000	1066	388	1.2	409	1.4	430	1.6	453	1.8	476	2.1	498	2.3	518	2.6	557	3.2	592	3.7		
13000	1155	414	1.4	433	1.6	452	1.8	472	2.1	493	2.4	514	2.6	535	2.9	573	3.5	607	4.1	640	4.7
14000	1243	440	1.7	458	1.9	475	2.1	493	2.4	512	2.7	532	3.0	552	3.3	589	3.9	623	4.5	655	5.1
15000	1332	467	2.0	483	2.2	500	2.5	516	2.7	533	3.0	551	3.3	569	3.6	606	4.3	640	4.9	671	5.6
16000	1421	493	2.3	509	2.6	525	2.9	540	3.1	555	3.4	571	3.7	588	4.1	623	4.7	656	5.4	688	6.1
17000	1510	520	2.7	535	3.0	550	3.3	564	3.6	579	3.9	593	4.2	609	4.5	641	5.2	673	5.9	704	6.6
18000	1599	547	3.1	562	3.4	576	3.7	589	4.0	603	4.4	617	4.7	630	5.0	660	5.7	690	6.5	721	7.2
19000	1687	575	3.6	588	3.9	602	4.3	615	4.6	628	4.9	640	5.2	653	5.6	680	6.3	709	7.1	738	7.9
20000	1776	602	4.2	615	4.5	628	4.8	640	5.1	653	5.5	665	5.8	677	6.2	702	6.9	728	7.7	756	8.5
21000	1865	629	4.8	642	5.1	654	5.4	666	5.8	678	6.1	690	6.5	701	6.9	725	7.6	749	8.4	774	9.2
22000	1954	657	5.4	669	5.8	681	6.1	692	6.5	704	6.8	715	7.2	726	7.6	748	8.4	771	9.2	794	10.0
23000	2043	685	6.1	696	6.5	708	6.8	719	7.2	730	7.6	740	8.0	751	8.4	772	9.2	794	10.0	816	10.9
24000	2131	712	6.9	724	7.2	735	7.6	745	8.0	756	8.4	766	8.8	776	9.2	797	10.0	817	10.9	838	11.8
26000	2309	768	8.6	779	9.0	789	9.4	799	9.8	809	10.3	818	10.7	828	11.1	847	12.0	866	12.9	884	13.8
28000	2487	824	10.6	834	11.0	843	11.5	853	11.9	862	12.4	871	12.8	880	13.3	898	14.2	915	15.2	933	16.1
30000	2664	880	12.9	889	13.3	898	13.8	907	14.3	916	14.8	924	15.3	933	15.8	950	16.7	966	17.7	982	18.8
32000	2842	937	15.5	945	16.0	954	16.5	962	17.0	970	17.5	978	18.0	986	18.5	1002	19.6	1018	20.6	1033	21.7
34000	3020	993	18.4	1001	19.0	1009	19.5	1017	20.1	1025	20.6	1033	21.1	1040	21.7	1055	22.8	1070	23.9	1085	25.0
36000	3197	1049	21.7	1057	22.3	1065	22.9	1072	23.5	1080	24.0	1087	24.6	1094	25.2	1109	26.3	1123	27.5	1136	28.7
38000	3375	1106	25.4	1114	26.1	1121	26.6	1128	27.2	1135	27.8	1142	28.4	1149	29.0	1162	30.3	1176	31.5	1189	32.7
40000	3552	1163	29.5	1170	30.2	1177	30.8	1184	31.4	1190	32.1	1197	32.7	1204	33.3	1217	34.6	1229	35.9	1242	37.2
42000	3730	1219	34.1	1226	34.7	1233	35.4	1239	36.0	1246	36.7	1252	37.4	1259	38.0	1271	39.3	1283	40.7	1295	42.0
44000	3908	1276	39.0	1283	39.7	1289	40.4	1295	41.1	1302	41.8	1308	42.5	1314	43.2	1326	44.6	1338	46.0	1349	47.4
Volume		2"SP		2-1/2"SP		3"SP		3-1/2"SP		4"SP		4-1/2"SP		5"SP		5-1/2"SP		6"SP		6-1/2"SP	
CFM	FPM	RPM	BHP	RPM	BHP	RPM	BHP	RPM	BHP	RPM	BHP	RPM	BHP	RPM	BHP	RPM	BHP	RPM	BHP	RPM	BHP
14000	1243	685	5.8																		
15000	1332	701	6.3																		
16000	1421	717	6.8	771	8.3																
17000	1510	733	7.4	787	8.9	837	10.5														
18000	1599	750	8.0	803	9.6	852	11.3														
19000	1687	766	8.7	819	10.3	868	12.0	913	13.8												
20000	1776	783	9.4	836	11.1	884	12.9	929	14.7	971	16.5										
21000	1865	801	10.1	852	11.9	900	13.7	945	15.6	986	17.5	1027	19.5								
22000	1954	819	10.9	869	12.8	917	14.7	961	16.6	1002	18.6	1042	20.6	1080	22.6						
23000	2043	839	11.8	886	13.7	934	15.6	978	17.6	1019	19.7	1058	21.8	1095	23.9	1131	26.0				
24000	2131	859	12.7	904	14.6	950	16.7	994	18.7	1035	20.8	1074	23.0	1111	25.2	1146	27.4	1181	29.6		
26000	2309	903	14.8	943	16.8	985	18.9	1027	21.1	1068	23.3	1106	25.6	1143	27.9	1178	30.2	1211	32.6	1244	35.0
28000	2487	950	17.1	986	19.2	1023	21.4	1062	23.7	1101	26.0	1140	28.4	1176	30.9	1211	33.3	1244	35.8	1275	38.3
30000	2664	999	19.8	1031	21.9	1065	24.2	1100	26.5	1136	29.0	1173	31.5	1209	34.1	1243	36.7	1276	39.3	1308	41.9
32000	2842	1048	22.8	1078	25.0	1109	27.4	1141	29.8	1174	32.3	1208	34.9	1242	37.6	1276	40.3	1309	43.1	1341	45.8
34000	3020	1099	26.1	1127	28.5	1156	30.9	1185	33.4	1215	36.0	1246	38.6	1278	41.4	1310	44.2	1342	47.1	1374	50.0
36000	3197	1150	29.9	1177	32.3	1204	34.8	1231	37.4	1258	40.0	1287	42.7	1316	45.6	1346	48.5	1377	51.4	1407	54.4
38000	3375	1202	33.9	1228	36.5	1253	39.1	1278	41.7	1304	44.5	1330	47.3	1357	50.2	1385	53.1	1413	56.1	1442	59.3
40000	3552	1254	38.5	1279	41.1	1303	43.8	1327	46.5	1351	49.3	1376	52.2	1400	55.2	1426	58.2	1452	61.3	1479	64.5
42000	3730	1307	43.4	1331	46.1	1354	48.9	1377	51.8	1400	54.7	1423	57.6	1446	60.6	1469	63.8	1493	66.9	1518	70.2
44000	3908	1361	48.8	1383	51.6	1405	54.5	1427	57.5	1449	60.4	1471	63.5	1493	66.6	1515	69.8	1537	73.0	1560	76.3
48000	4263	1468	61.0	1489	64.0	1509	67.1	1530	70.3	1550	73.5	1570	76.7	1589	80.0	1609	83.3	1629	86.7	1649	90.1
52000	4618	1576	75.2	1596	78.5	1615	81.8	1634	85.1	1653	88.6	1671	92.0	1690	95.5	1707	99.0	1726	102.6	1744	106.1
56000	4973	1686	91.6	1704	95.2	1722	98.7	1740	102.3	1757	105.9	1774	109.5	1791	113.2	1808	116.9	1825	120.6	1842	124.4
Volume		7"SP		8"SP		9"SP		10"SP		11"SP		12"SP		13"SP		14"SP		15"SP		16"SP	
CFM	FPM	RPM	BHP	RPM	BHP	RPM	BHP	RPM	BHP	RPM	BHP	RPM	BHP	RPM	BHP	RPM	BHP	RPM	BHP	RPM	BHP
26000	2309	1276	37.4																		
28000	2487	1306	40.9	1366	46.0																
30000	2664	1339	44.7	1397	50.0	1453	55.5														
32000	2842	1371	48.6	1429	54.3	1484	60.1	1536	65.9												
34000	3020	1404	52.9	1462	58.9	1516	64.9	1567	71.0	1617	77.2	1666	83.4								
36000	3197	1437	57.5	1494	63.7	1548	70.0	1600	76.4	1648	82.8	1696	89.3	1741	95.8						
38000	3375	1471	62.4	1527	68.9	1581	75.4	1632	82.1	1680	88.8	1727	95.5	1772	102.3	1816	109.2	1859	116.2		
40000	3552	1506	67.8	1560	74.4	1614	81.2	1665	88.1	1713	95.0	1759	102.0	1803	109.1	1847	116.3	1889	123.6	1930	130.7
42000	3730	1544	73.5	1595	80.3	1647	87.3	1697	94.5	1746	101.7	1792	108.9	1836	116.3	1878	123.7	1920	131.3	1960	138.7
44000	3908	1583	79.7	1632	86.6	1681	93.8	1731	101.2	1779	108.7	1824	116.2	1868	123.8	1911	131.5	1952	139.3	1991	147.0
48000	4263	1670	93.7	1712	100.9	1755	108.4	1800	116.1	1846	124.0	1890	132.0	1934	140.0	1976	148.2				
52000	4618	1762	109.8	1799	117.3	1837															

Wheel Diameter = 36.50 in.
 Outlet Area = 13.78 sq. ft. inside
 Maximum BHP = 33.2 x (RPM/1000)³
 Tip Speed, fpm = 9.56 x RPM

Size

3650 DIDW

Design 5020 Centrifugal BI Fans

- Class I RPM 1106
- Class II RPM 1440
- Class III RPM 1811

Volume		1/4"SP		3/8"SP		1/2"SP		5/8"		3/4"SP		7/8"SP		1"SP		1-1/4"SP		1-1/2"SP		1-3/4"SP	
CFM	FPM	RPM	BHP	RPM	BHP	RPM	BHP	RPM	BHP	RPM	BHP	RPM	BHP	RPM	BHP	RPM	BHP	RPM	BHP	RPM	BHP
11000	799	285	0.8	312	1.0	339	1.2	363	1.5	385	1.7										
12000	871	302	0.9	326	1.1	351	1.4	376	1.7	397	1.9	418	2.2	437	2.5						
13000	944	320	1.1	341	1.3	364	1.6	388	1.9	409	2.1	430	2.4	449	2.7						
14000	1016	338	1.3	358	1.5	378	1.8	400	2.1	422	2.4	442	2.7	460	3.0	495	3.6				
15000	1089	357	1.5	375	1.7	394	2.0	414	2.3	434	2.6	454	3.0	473	3.3	507	4.0	539	4.7		
16000	1162	376	1.7	393	2.0	410	2.3	428	2.6	447	2.9	466	3.3	485	3.6	519	4.3	550	5.0	579	5.8
17000	1234	396	2.0	412	2.3	428	2.6	444	2.9	461	3.2	479	3.6	497	3.9	531	4.7	562	5.5	591	6.2
18000	1307	415	2.3	430	2.6	445	2.9	461	3.2	476	3.6	493	3.9	510	4.3	543	5.1	574	5.9	603	6.7
20000	1452	454	3.0	469	3.3	482	3.7	496	4.0	509	4.4	523	4.8	538	5.1	568	6.0	599	6.8	627	7.7
22000	1597	494	3.8	507	4.2	520	4.6	532	4.9	545	5.3	557	5.7	570	6.1	596	7.0	624	7.9	651	8.8
24000	1742	535	4.8	547	5.2	559	5.6	570	6.0	581	6.4	593	6.9	604	7.3	627	8.2	651	9.1	677	10.1
26000	1887	575	6.0	587	6.4	598	6.8	608	7.3	619	7.7	629	8.2	640	8.6	661	9.5	682	10.5	705	11.5
28000	2033	616	7.4	627	7.8	637	8.3	647	8.7	657	9.2	667	9.6	677	10.1	696	11.1	715	12.1	735	13.2
30000	2178	657	8.9	667	9.4	677	9.9	686	10.4	696	10.8	705	11.3	714	11.8	732	12.9	750	13.9	768	15.0
32000	2323	698	10.7	708	11.2	717	11.7	726	12.2	735	12.7	744	13.3	752	13.8	769	14.9	786	16.0	803	17.1
34000	2468	740	12.7	749	13.2	757	13.7	766	14.3	774	14.8	783	15.4	791	16.0	807	17.1	823	18.2	839	19.4
36000	2613	781	14.9	790	15.5	798	16.0	806	16.6	814	17.2	822	17.8	830	18.4	845	19.6	860	20.8	875	22.0
38000	2759	823	17.4	831	18.0	839	18.6	846	19.2	854	19.8	862	20.4	869	21.0	884	22.3	898	23.5	912	24.8
40000	2904	865	20.2	872	20.8	880	21.4	887	22.0	894	22.7	902	23.3	909	24.0	923	25.3	936	26.6	950	27.9
42000	3049	906	23.2	914	23.9	921	24.5	928	25.2	935	25.8	942	26.5	949	27.2	962	28.5	975	29.9	988	31.3
44000	3194	948	26.5	955	27.2	962	27.9	969	28.6	975	29.3	982	30.0	989	30.7	1001	32.1	1014	33.6	1027	35.0
46000	3339	990	30.2	997	30.9	1003	31.6	1010	32.4	1016	33.1	1022	33.8	1029	34.5	1041	36.0	1053	37.5	1066	39.0
48000	3485	1032	34.2	1038	34.9	1045	35.7	1051	36.4	1057	37.2	1063	37.9	1069	38.7	1081	40.2	1093	41.8	1105	43.3
50000	3630	1073	38.5	1080	39.3	1086	40.1	1092	40.8	1098	41.6	1104	42.4	1110	43.2	1121	44.8	1133	46.4	1144	48.0
55000	3993	1178	50.8	1184	51.7	1190	52.6	1195	53.5	1201	54.3	1206	55.2	1212	56.1	1222	57.8	1233	59.5	1243	61.3
60000	4356	1284	65.7	1289	66.6	1294	67.6	1299	68.5	1304	69.4	1309	70.4	1314	71.3	1324	73.2	1334	75.1	1343	77.0
Volume		2"SP		2-1/2"SP		3"SP		3-1/2"SP		4"SP		4-1/2"SP		5"SP		5-1/2"SP		6"SP		6-1/2"SP	
CFM	FPM	RPM	BHP	RPM	BHP	RPM	BHP	RPM	BHP	RPM	BHP	RPM	BHP	RPM	BHP	RPM	BHP	RPM	BHP	RPM	BHP
17000	1234	618	7.0																		
18000	1307	629	7.5																		
20000	1452	653	8.6	702	10.4																
22000	1597	678	9.8	726	11.8	770	13.8														
24000	1742	702	11.1	750	13.2	794	15.4	834	17.5	873	19.8										
26000	1887	728	12.6	774	14.8	818	17.1	858	19.4	896	21.8	932	24.2								
28000	2033	756	14.3	800	16.6	842	19.0	882	21.4	919	23.9	955	26.5	989	29.0	1021	31.6				
30000	2178	787	16.2	826	18.5	867	21.0	907	23.7	944	26.3	978	28.9	1012	31.6	1044	34.3	1074	37.1		
32000	2323	820	18.3	855	20.7	893	23.3	931	26.0	968	28.8	1003	31.6	1036	34.4	1067	37.3	1097	40.2	1127	43.1
34000	2468	854	20.6	887	23.2	921	25.8	957	28.6	993	31.5	1027	34.4	1060	37.4	1091	40.4	1121	43.4	1150	46.5
36000	2613	890	23.3	920	25.8	951	28.6	984	31.4	1018	34.4	1052	37.4	1085	40.5	1116	43.7	1145	46.8	1174	50.0
38000	2759	926	26.1	955	28.8	984	31.6	1014	34.5	1045	37.5	1077	40.7	1109	43.9	1140	47.2	1170	50.5	1198	53.8
40000	2904	964	29.3	990	32.0	1017	34.9	1045	37.9	1074	41.0	1104	44.2	1134	47.5	1164	50.9	1194	54.3	1222	57.8
42000	3049	1001	32.7	1027	35.6	1052	38.5	1078	41.6	1105	44.8	1132	48.0	1161	51.4	1190	54.9	1219	58.4	1247	62.0
44000	3194	1039	36.5	1064	39.4	1088	42.5	1112	45.6	1137	48.9	1163	52.2	1189	55.6	1217	59.2	1244	62.8	1271	66.5
46000	3339	1077	40.5	1101	43.6	1124	46.7	1147	49.9	1171	53.3	1195	56.7	1219	60.2	1245	63.8	1271	67.5	1297	71.3
48000	3485	1116	44.9	1139	48.1	1161	51.3	1183	54.6	1205	58.0	1228	61.5	1251	65.1	1275	68.8	1299	72.6	1324	76.4
50000	3630	1155	49.6	1177	52.9	1198	56.2	1219	59.6	1241	63.1	1262	66.7	1284	70.4	1306	74.1	1329	77.9	1352	81.9
55000	3993	1253	63.0	1273	66.6	1293	70.2	1312	73.8	1332	77.5	1351	81.4	1370	85.2	1389	89.1	1409	93.1	1429	97.2
60000	4356	1353	78.9	1371	82.7	1390	86.6	1408	90.5	1425	94.4	1443	98.5	1460	102.5	1478	106.7	1495	110.9	1513	115.2
65000	4719	1453	97.4	1471	101.5	1487	105.6	1504	109.8	1521	114.0	1537	118.3	1553	122.6	1569	127.0	1585	131.4	1602	135.9
70000	5082	1555	118.8	1571	123.2	1586	127.6	1602	132.1	1618	136.5	1633	141.0	1648	145.7	1663	150.2	1678	154.9	1693	159.6
Volume		7"SP		8"SP		9"SP		10"SP		11"SP		12"SP		13"SP		14"SP		15"SP		16"SP	
CFM	FPM	RPM	BHP	RPM	BHP	RPM	BHP	RPM	BHP	RPM	BHP	RPM	BHP	RPM	BHP	RPM	BHP	RPM	BHP	RPM	BHP
32000	2323	1156	46.0																		
34000	2468	1178	49.5	1233	55.8																
36000	2613	1202	53.2	1255	59.8	1306	66.4														
38000	2759	1226	57.1	1278	63.9	1328	70.8	1377	77.8												
40000	2904	1250	61.3	1302	68.3	1351	75.5	1399	82.8	1444	90.1										
42000	3049	1274	65.6	1326	72.9	1375	80.4	1422	87.9	1467	95.5	1510	103.2								
44000	3194	1299	70.2	1350	77.8	1399	85.6	1446	93.4	1490	101.2	1533	109.1	1574	117.1						
46000	3339	1323	75.1	1375	83.0	1424	91.0	1470	99.0	1514	107.1	1556	115.4	1596	123.6	1636	131.9				
48000	3485	1349	80.3	1399	88.4	1448	96.6	1494	104.9	1537	113.3	1579	121.8	1620	130.3	1659	138.9	1697	147.5	1735	156.5
50000	3630	1376	85.9	1425	94.1	1472	102.5	1518	111.1	1561	119.7	1603	128.5	1644	137.4	1682	146.2	1719	155.1	1757	164.1
55000	3993	1450	101.4	1492	110.0	1535	118.8	1579	127.9	1622	137.2	1664	146.6	1704	156.1	1742	165.7	1778	175.2		
60000	4356	1531	119.5	1568	128.4	1606	137.6	1645	147.1	1685	156.8	1725	166.7	1764	176.8	1802	187.1				
65000	4719	1618	140.4	1650	149.6	1683	159.2	1718	169.0	1753	179.1	1790	189.4								

Wheel Diameter = 40.25 in.
 Outlet Area = 16.76 sq. ft. inside
 Maximum BHP = 54.1 x (RPM/1000)³
 Tip Speed, fpm = 10.5 x RPM

Size

4025 DIDW

Design 5020 Centrifugal BI Fans

Class I RPM 1003
 Class II RPM 1306
 Class III RPM 1643

Volume		1/4"SP		3/8"SP		1/2"SP		5/8"SP		3/4"SP		7/8"SP		1"SP		1-1/4"SP		1-1/2"		1-3/4"SP	
CFM	FPM	RPM	BHP	RPM	BHP	RPM	BHP	RPM	BHP	RPM	BHP	RPM	BHP	RPM	BHP	RPM	BHP	RPM	BHP	RPM	BHP
14000	836	266	1.0	289	1.3	313	1.6	335	1.9	355	2.2	374	2.5								
15000	895	279	1.2	300	1.5	322	1.8	344	2.1	364	2.4	382	2.8	400	3.1						
16000	955	293	1.3	312	1.6	332	2.0	353	2.3	373	2.6	391	3.0	409	3.4						
17000	1015	307	1.5	324	1.8	343	2.2	363	2.5	382	2.9	400	3.3	417	3.6	449	4.4				
18000	1075	321	1.7	337	2.1	354	2.4	373	2.8	391	3.1	410	3.5	426	3.9	458	4.7	486	5.6		
19000	1134	335	2.0	350	2.3	366	2.7	383	3.0	401	3.4	419	3.8	436	4.2	467	5.1	495	6.0		
20000	1194	349	2.2	364	2.6	379	2.9	395	3.3	411	3.7	428	4.1	445	4.6	476	5.4	504	6.3	530	7.3
21000	1254	363	2.5	378	2.9	392	3.2	407	3.6	422	4.0	438	4.5	454	4.9	485	5.8	513	6.8	539	7.7
22000	1313	378	2.8	392	3.2	405	3.6	419	4.0	433	4.4	448	4.8	464	5.3	494	6.2	522	7.2	547	8.2
23000	1373	393	3.2	406	3.5	419	3.9	432	4.3	445	4.8	459	5.2	474	5.7	503	6.7	531	7.7	556	8.7
24000	1433	407	3.5	420	3.9	433	4.3	445	4.7	458	5.2	471	5.6	484	6.1	512	7.1	540	8.1	566	9.2
26000	1552	437	4.3	449	4.8	461	5.2	472	5.6	484	6.1	495	6.6	507	7.1	532	8.1	558	9.2	584	10.3
28000	1672	467	5.3	478	5.7	489	6.2	500	6.7	511	7.1	521	7.6	532	8.1	555	9.2	578	10.3	602	11.5
30000	1791	497	6.3	508	6.8	518	7.3	529	7.8	539	8.3	548	8.8	558	9.4	579	10.5	600	11.6	622	12.8
32000	1910	528	7.6	538	8.1	548	8.6	557	9.1	567	9.6	576	10.2	585	10.7	604	11.9	623	13.1	643	14.3
34000	2030	558	8.9	568	9.5	577	10.0	586	10.6	595	11.1	604	11.7	613	12.3	630	13.5	648	14.7	666	16.0
36000	2149	589	10.4	598	11.0	607	11.6	615	12.2	624	12.8	632	13.4	641	14.0	657	15.2	674	16.5	691	17.8
38000	2269	619	12.2	628	12.8	637	13.4	645	14.0	653	14.6	661	15.2	669	15.9	685	17.1	700	18.5	716	19.8
40000	2388	650	14.0	658	14.7	666	15.3	675	16.0	682	16.6	690	17.2	698	17.9	713	19.2	728	20.6	742	22.0
42000	2507	681	16.1	689	16.8	697	17.4	704	18.1	712	18.8	719	19.5	727	20.2	741	21.6	755	23.0	769	24.4
44000	2627	712	18.4	720	19.1	727	19.8	734	20.5	742	21.2	749	21.9	756	22.6	770	24.1	783	25.5	797	27.0
48000	2865	774	23.6	781	24.3	788	25.1	795	25.9	801	26.6	808	27.4	814	28.2	827	29.7	840	31.3	852	32.9
52000	3104	836	29.7	843	30.5	849	31.3	856	32.2	862	33.0	868	33.8	874	34.7	886	36.3	898	38.0	909	39.7
56000	3343	898	36.8	905	37.7	911	38.6	917	39.5	923	40.4	928	41.2	934	42.1	945	43.9	956	45.7	967	47.5
60000	3582	961	45.0	967	46.0	972	46.9	978	47.8	983	48.8	989	49.8	994	50.7	1005	52.6	1015	54.5	1026	56.4
65000	3880	1039	56.9	1045	57.9	1050	58.9	1055	59.9	1060	61.0	1065	62.0	1070	63.0	1080	65.0	1090	67.1	1099	69.2
70000	4179	1118	70.7	1122	71.8	1127	72.9	1132	74.0	1137	75.1	1142	76.2	1147	77.3	1156	79.5	1165	81.7	1174	83.9
Volume		2"SP		2-1/2"SP		3"SP		3-1/2"SP		4"SP		4-1/2"SP		5"SP		5-1/2"SP		6"SP		6-1/2"SP	
CFM	FPM	RPM	BHP	RPM	BHP	RPM	BHP	RPM	BHP	RPM	BHP	RPM	BHP	RPM	BHP	RPM	BHP	RPM	BHP	RPM	BHP
21000	1254	563	8.7																		
22000	1313	572	9.2																		
23000	1373	581	9.7	626	11.9																
24000	1433	590	10.3	634	12.5																
26000	1552	608	11.4	651	13.8	692	16.2														
28000	1672	626	12.7	670	15.2	709	17.7	746	20.3												
30000	1791	644	14.1	688	16.7	727	19.4	764	22.1	798	24.8										
32000	1910	664	15.6	706	18.3	745	21.1	781	24.0	816	26.9	848	29.8								
34000	2030	685	17.3	725	20.1	763	23.0	799	26.0	833	29.1	865	32.1	896	35.3	926	38.4				
36000	2149	708	19.2	744	22.1	782	25.1	818	28.2	851	31.4	883	34.6	913	37.8	942	41.1	971	44.4		
38000	2269	732	21.2	766	24.2	801	27.3	836	30.5	869	33.8	901	37.2	931	40.5	960	44.0	987	47.4	1014	50.9
40000	2388	757	23.5	788	26.5	821	29.7	855	33.0	888	36.4	919	39.9	949	43.4	977	47.0	1005	50.6	1031	54.2
42000	2507	783	25.9	812	29.0	843	32.3	874	35.7	906	39.2	937	42.8	967	46.5	995	50.1	1023	53.9	1049	57.6
44000	2627	810	28.6	837	31.7	865	35.1	895	38.5	925	42.1	956	45.9	985	49.7	1014	53.5	1041	57.3	1066	61.2
48000	2865	865	34.6	889	37.9	914	41.4	940	45.0	967	48.7	995	52.6	1023	56.6	1050	60.7	1077	64.8	1103	69.0
52000	3104	921	41.5	944	45.0	966	48.6	989	52.4	1013	56.3	1037	60.3	1062	64.4	1088	68.7	1114	73.0	1139	77.5
56000	3343	978	49.4	999	53.1	1020	56.9	1041	60.9	1062	64.9	1084	69.1	1106	73.3	1129	77.7	1153	82.2	1177	86.8
60000	3582	1036	58.4	1056	62.3	1075	66.4	1095	70.5	1114	74.7	1134	79.0	1154	83.4	1175	87.9	1196	92.5	1218	97.3
65000	3880	1109	71.3	1127	75.5	1146	79.8	1164	84.2	1182	88.6	1200	93.1	1218	97.7	1236	102.4	1255	107.2	1274	112.1
70000	4179	1183	86.1	1200	90.6	1217	95.1	1234	99.8	1251	104.5	1267	109.2	1284	114.1	1301	118.9	1317	123.9	1334	129.0
75000	4477	1257	103.1	1274	107.8	1290	112.7	1306	117.5	1321	122.5	1337	127.5	1352	132.5	1368	137.6	1383	142.8	1399	148.1
80000	4776	1332	122.3	1348	127.4	1363	132.4	1378	137.6	1393	142.7	1408	148.0	1422	153.3	1437	158.7	1451	164.0	1465	169.6
85000	5074	1408	143.9	1422	149.3	1437	154.6	1451	160.0	1465	165.5	1479	170.9	1493	176.5	1506	182.1	1520	187.8	1533	193.4
Volume		7"SP		8"SP		9"SP		10"SP		11"SP		12"SP		13"SP		14"SP		15"SP		16"SP	
CFM	FPM	RPM	BHP	RPM	BHP	RPM	BHP	RPM	BHP	RPM	BHP	RPM	BHP	RPM	BHP	RPM	BHP	RPM	BHP	RPM	BHP
40000	2388	1057	57.9																		
42000	2507	1074	61.4	1123	69.1																
44000	2627	1092	65.2	1140	73.1	1186	81.2														
48000	2865	1128	73.1	1175	81.7	1220	90.3	1263	99.0	1305	107.9										
52000	3104	1164	81.9	1211	90.9	1255	100.1	1297	109.3	1338	118.7	1377	128.1								
56000	3343	1201	91.5	1247	101.1	1292	110.8	1333	120.6	1373	130.5	1411	140.5	1448	150.5	1484	160.6	1520	170.9		
60000	3582	1240	102.2	1284	112.1	1328	122.2	1369	132.5	1409	143.0	1446	153.5	1483	164.1	1519	174.9	1553	185.6	1586	196.3
65000	3880	1293	117.1	1333	127.4	1374	138.1	1415	149.0	1454	160.1	1492	171.3	1528	182.4	1562	193.8	1596	205.3	1629	216.8
70000	4179	1352	134.1	1387	144.8	1424	155.8	1462	167.1	1500	178.7	1537	190.5	1573	202.5	1608	214.5	1641	226.5		
75000	4477	1414	153.4	1446	164.4	1479	175.7	1513	187.4	1548	199.5	1583	211.7	1618	224.1						
80000	4776	1479	175.1	1509	186.4	1538	198.1	1569	210.1	1600	222.3	1633	234.9								
85000	5074	1547	199.2																		

Wheel Diameter = 44.50 in.
 Outlet Area = 20.49 sq. ft. inside
 Maximum BHP = 90.0 x (RPM/1000)³
 Tip Speed, fpm = 11.7 x RPM

Size

4450 DIDW

Design 5020 Centrifugal BI Fans

Class I RPM 913
 Class II RPM 1189
 Class III RPM 1496

Volume O.Vel		1/4"SP		3/8"SP		1/2"SP		5/8"SP		3/4"SP		7/8"SP		1"SP		1-1/4"SP		1-1/2"SP		1-3/4"SP	
CFM	FPM	RPM	BHP	RPM	BHP	RPM	BHP	RPM	BHP	RPM	BHP	RPM	BHP	RPM	BHP	RPM	BHP	RPM	BHP	RPM	BHP
16000	781	232	1.1	254	1.4	276	1.8	296	2.2	315	2.5	333	2.9								
17000	830	241	1.3	262	1.6	283	2.0	302	2.3	321	2.7	338	3.1	355	3.6						
18000	878	251	1.4	270	1.8	290	2.1	309	2.5	327	2.9	344	3.4	361	3.8						
19000	927	261	1.6	278	1.9	297	2.3	316	2.7	334	3.2	350	3.6	366	4.0	397	5.0				
20000	976	271	1.7	288	2.1	305	2.5	323	3.0	340	3.4	357	3.8	372	4.3	402	5.3				
21000	1025	281	1.9	297	2.3	313	2.8	330	3.2	347	3.6	364	4.1	379	4.6	408	5.6	436	6.6		
22000	1074	292	2.2	307	2.6	322	3.0	338	3.4	354	3.9	370	4.4	386	4.9	414	5.9	441	6.9	468	8.0
23000	1123	302	2.4	317	2.8	331	3.2	346	3.7	362	4.2	377	4.7	392	5.2	420	6.2	447	7.3	472	8.4
24000	1171	313	2.6	327	3.1	341	3.5	355	4.0	369	4.5	384	5.0	399	5.5	427	6.6	453	7.7	478	8.8
26000	1269	334	3.2	347	3.7	360	4.1	373	4.6	386	5.1	400	5.7	414	6.2	441	7.4	466	8.5	490	9.7
28000	1367	356	3.8	368	4.3	380	4.8	392	5.4	404	5.9	416	6.5	429	7.0	455	8.2	479	9.5	502	10.7
30000	1464	378	4.6	390	5.1	401	5.6	412	6.2	423	6.7	434	7.3	445	7.9	469	9.2	493	10.5	516	11.8
32000	1562	400	5.4	411	5.9	422	6.5	432	7.1	442	7.7	453	8.3	463	8.9	485	10.2	508	11.5	530	12.9
34000	1659	422	6.3	433	6.9	443	7.5	453	8.1	463	8.7	472	9.4	482	10.0	502	11.3	523	12.7	544	14.2
36000	1757	445	7.3	455	8.0	465	8.6	474	9.2	483	9.9	492	10.5	501	11.2	520	12.6	539	14.0	559	15.5
38000	1855	467	8.5	477	9.1	486	9.8	495	10.5	504	11.2	513	11.8	521	12.5	539	14.0	556	15.4	575	17.0
40000	1952	490	9.7	499	10.4	508	11.1	517	11.8	525	12.5	533	13.3	542	14.0	558	15.5	575	17.0	592	18.6
44000	2147	535	12.6	544	13.4	552	14.2	560	14.9	568	15.7	576	16.5	583	17.3	598	18.9	613	20.5	628	22.2
48000	2343	581	16.1	589	16.9	597	17.7	604	18.6	611	19.4	618	20.3	626	21.1	639	22.8	653	24.6	667	26.3
52000	2538	627	20.1	634	21.0	641	21.9	648	22.8	655	23.7	662	24.6	669	25.6	682	27.4	694	29.3	707	31.2
56000	2733	673	24.9	680	25.8	687	26.8	693	27.7	700	28.7	706	29.7	712	30.7	724	32.6	736	34.6	748	36.7
60000	2928	719	30.3	726	31.3	732	32.3	738	33.4	744	34.4	750	35.4	756	36.5	768	38.6	779	40.7	790	42.8
65000	3172	777	38.1	783	39.2	789	40.3	795	41.4	800	42.5	806	43.7	811	44.8	822	47.0	833	49.3	843	51.6
70000	3416	835	47.2	841	48.4	846	49.6	852	50.8	857	52.0	862	53.2	867	54.4	877	56.8	887	59.2	897	61.7
75000	3660	893	57.7	899	59.0	904	60.2	909	61.5	914	62.8	919	64.1	923	65.4	933	67.9	942	70.5	952	73.1
80000	3904	952	69.6	956	71.0	961	72.4	966	73.7	971	75.1	975	76.4	980	77.8	989	80.5	998	83.3	1007	86.1
85000	4148	1010	83.1	1014	84.6	1019	86.0	1024	87.5	1028	88.9	1032	90.4	1037	91.8	1045	94.7	1054	97.6	1062	100.6
90000	4392	1068	98.3	1072	99.8	1077	101.4	1081	103.0	1085	104.5	1090	106.0	1094	107.5	1102	110.6	1110	113.6	1118	116.7
Volume O.Vel		2"SP		2-1/2"SP		3"SP		3-1/2"SP		4"SP		4-1/2"SP		5"SP		5-1/2"SP		6"SP		6-1/2"SP	
CFM	FPM	RPM	BHP	RPM	BHP	RPM	BHP	RPM	BHP	RPM	BHP	RPM	BHP	RPM	BHP	RPM	BHP	RPM	BHP	RPM	BHP
24000	1171	502	10.0																		
26000	1269	513	11.0	557	13.5																
28000	1367	524	12.0	567	14.7																
30000	1464	537	13.1	578	15.9	618	18.8														
32000	1562	551	14.3	591	17.2	628	20.2	665	23.3												
34000	1659	565	15.6	604	18.7	640	21.8	675	25.0	710	28.3										
36000	1757	579	17.0	617	20.2	653	23.4	687	26.8	720	30.2	752	33.7								
38000	1855	594	18.6	631	21.8	666	25.2	699	28.7	731	32.2	762	35.8	793	39.6						
40000	1952	609	20.2	645	23.6	680	27.1	713	30.7	743	34.3	774	38.0	803	41.9	832	45.8				
44000	2147	643	23.9	675	27.5	708	31.2	740	35.0	770	38.9	798	42.9	826	46.9	854	51.1	880	55.2	907	59.5
48000	2343	680	28.2	708	31.9	738	35.8	768	39.9	797	44.0	825	48.3	852	52.6	878	56.9	904	61.3	928	65.8
52000	2538	719	33.1	745	37.0	771	41.1	798	45.3	826	49.7	853	54.2	879	58.7	905	63.3	929	68.0	953	72.8
56000	2733	760	38.7	783	42.8	807	47.1	831	51.5	856	56.0	882	60.7	907	65.5	932	70.4	956	75.3	979	80.2
60000	2928	801	45.0	823	49.3	844	53.8	866	58.4	889	63.1	912	68.0	936	72.9	960	78.0	984	83.2	1007	88.5
65000	3172	853	53.9	874	58.6	894	63.3	914	68.1	934	73.1	955	78.2	976	83.4	998	88.7	1019	94.1	1041	99.6
70000	3416	907	64.1	926	69.1	944	74.1	963	79.2	981	84.4	1000	89.8	1019	95.1	1038	100.6	1058	106.3	1079	112.1
75000	3660	961	75.8	979	81.1	996	86.4	1013	91.7	1031	97.2	1048	102.8	1065	108.4	1083	114.1	1101	120.0	1119	125.9
80000	3904	1015	88.8	1032	94.4	1049	100.1	1065	105.8	1081	111.5	1097	117.3	1113	123.2	1129	129.1	1146	135.2	1162	141.3
85000	4148	1070	103.5	1086	109.5	1102	115.3	1117	121.3	1133	127.4	1148	133.4	1163	139.6	1178	145.8	1193	152.1	1208	158.5
90000	4392	1126	119.9	1141	126.0	1156	132.3	1171	138.6	1185	144.9	1200	151.4	1214	157.7	1228	164.3	1242	170.7	1256	177.5
95000	4636	1181	137.9	1196	144.4	1210	151.0	1224	157.6	1238	164.3	1252	170.9	1265	177.7	1279	184.4	1292	191.3	1306	198.1
100000	4880	1237	157.9	1251	164.8	1265	171.5	1278	178.6	1292	185.4	1305	192.5	1318	199.4	1331	206.5	1343	213.5	1356	220.7
Volume O.Vel		7"SP		8"SP		9"SP		10"SP		11"SP		12"SP		13"SP		14"SP		15"SP		16"SP	
CFM	FPM	RPM	BHP	RPM	BHP	RPM	BHP	RPM	BHP	RPM	BHP	RPM	BHP	RPM	BHP	RPM	BHP	RPM	BHP	RPM	BHP
44000	2147	933	63.9																		
48000	2343	953	70.3																		
52000	2538	976	77.5	1022	87.2	1067	97.2	1111	107.5												
56000	2733	1002	85.3	1046	95.4	1088	105.9	1130	116.6	1171	127.5										
60000	2928	1029	93.7	1071	104.4	1112	115.2	1152	126.3	1191	137.6	1230	149.1	1268	160.9						
65000	3172	1063	105.2	1105	116.5	1145	128.0	1183	139.7	1220	151.6	1256	163.6	1292	175.8	1328	188.2	1363	201.0		
70000	3416	1099	117.9	1140	129.9	1178	142.0	1216	154.2	1252	166.6	1287	179.3	1321	192.1	1355	205.1	1388	218.1	1421	231.5
75000	3660	1137	132.0	1175	144.4	1213	157.2	1250	170.2	1285	183.2	1319	196.4	1352	209.6	1384	223.1	1416	236.9	1448	250.8
80000	3904	1179	147.6	1214	160.4	1249	173.7	1285	187.2	1319	200.9	1353	214.7	1385	228.6	1417	242.8	1447	257.1	1477	271.3
85000	4148	1224	164.9	1255	178.2	1288	191.8	1321	205.8	1354	220.0	1387	234.5	1419	249.2	1450	263.9	1480	278.6		
90000	4392	1271	184.0	1299	197.7	1329	211.7	1360	226.1	1391	240.8	1423	255.9	1454	27						

Wheel Diameter = 49.00 in.
 Outlet Area = 24.81 sq. ft. inside
 Maximum BHP = 146 x (RPM/1000)³
 Tip Speed, fpm = 12.8 x RPM

Size

4900 DIDW

Design 5020 Centrifugal BI Fans

Class I RPM 828
 Class II RPM 1078
 Class III RPM 1357

Volume		1/4"SP		3/8"		1/2"SP		5/8"SP		3/4"SP		7/8"SP		1"SP		1-1/4"SP		1-1/2"SP		1-3/4"SP		
CFM	FPM	RPM	BHP	RPM	BHP	RPM	BHP	RPM	BHP	RPM	BHP	RPM	BHP	RPM	BHP	RPM	BHP	RPM	BHP	RPM	BHP	
20000	805	215	1.4	234	1.8	254	2.3	271	2.7	288	3.2	305	3.7	321	4.2							
22000	886	229	1.7	246	2.2	264	2.6	282	3.1	298	3.6	313	4.1	328	4.6							
24000	966	244	2.1	259	2.5	275	3.0	292	3.5	308	4.1	323	4.6	337	5.1	365	6.3					
26000	1047	260	2.5	274	3.0	288	3.5	303	4.0	318	4.6	333	5.1	347	5.7	373	6.9	398	8.2			
28000	1127	275	2.9	288	3.4	301	4.0	315	4.5	329	5.1	343	5.7	357	6.3	382	7.6	406	8.9	430	10.3	
30000	1208	291	3.4	304	4.0	316	4.5	328	5.1	341	5.7	354	6.4	367	7.0	392	8.3	416	9.7	438	11.1	
32000	1288	308	4.0	319	4.6	331	5.2	342	5.8	354	6.4	366	7.1	378	7.7	403	9.1	425	10.6	447	12.0	
34000	1369	324	4.7	335	5.3	346	5.9	356	6.5	367	7.2	378	7.8	390	8.5	413	10.0	435	11.5	457	13.0	
36000	1449	340	5.4	351	6.0	361	6.7	371	7.3	381	8.0	392	8.7	402	9.4	424	10.9	446	12.5	467	14.1	
38000	1530	357	6.2	367	6.9	377	7.5	386	8.2	396	8.9	405	9.6	415	10.4	436	11.9	456	13.5	477	15.2	
40000	1610	373	7.1	383	7.8	393	8.5	402	9.2	411	9.9	420	10.7	429	11.4	448	13.0	468	14.7	487	16.4	
44000	1771	407	9.1	416	9.8	425	10.6	433	11.4	442	12.2	450	13.0	458	13.8	475	15.5	492	17.2	510	19.1	
48000	1932	441	11.5	449	12.3	457	13.1	465	14.0	473	14.8	481	15.7	488	16.6	503	18.4	518	20.2	534	22.1	
52000	2093	475	14.3	483	15.2	490	16.1	498	17.0	505	17.9	512	18.8	519	19.8	533	21.7	547	23.6	561	25.6	
56000	2254	509	17.5	516	18.5	523	19.5	530	20.4	537	21.4	544	22.4	551	23.4	564	25.4	576	27.5	589	29.6	
60000	2415	543	21.2	550	22.3	557	23.3	563	24.4	570	25.4	576	26.5	583	27.5	595	29.6	607	31.8	619	34.0	
65000	2616	586	26.6	593	27.7	599	28.9	605	30.0	611	31.1	617	32.2	623	33.4	635	35.7	646	38.0	657	40.3	
70000	2818	630	32.9	635	34.1	641	35.3	647	36.5	653	37.7	658	38.9	664	40.1	675	42.6	685	45.1	696	47.5	
75000	3019	673	40.1	678	41.3	684	42.6	689	43.9	695	45.2	700	46.5	705	47.8	715	50.4	725	53.0	735	55.7	
80000	3220	716	48.2	722	49.6	727	51.0	732	52.3	737	53.7	742	55.1	747	56.5	756	59.2	766	62.1	775	64.8	
85000	3421	760	57.5	765	59.0	770	60.4	774	61.8	779	63.3	784	64.7	789	66.2	798	69.2	807	72.1	816	75.1	
90000	3623	803	67.8	808	69.4	813	70.9	817	72.5	822	74.0	826	75.6	831	77.1	839	80.2	848	83.3	857	86.4	
95000	3824	847	79.4	851	81.1	856	82.7	860	84.3	864	85.9	869	87.6	873	89.2	881	92.4	890	95.7	898	99.0	
100000	4025	890	92.3	895	94.0	899	95.7	903	97.4	907	99.1	911	100.8	915	102.5	923	105.9	931	109.4	939	112.8	
105000	4226	934	106.4	938	108.2	942	110.1	946	111.9	950	113.6	954	115.4	958	117.2	966	120.8	973	124.3	981	128.0	
Volume		2"SP		2-1/2"SP		3"SP		3-1/2"SP		4"SP		4-1/2"SP		5"SP		5-1/2"SP		6"SP		6-1/2"SP		
CFM	FPM	RPM	BHP	RPM	BHP	RPM	BHP	RPM	BHP	RPM	BHP	RPM	BHP	RPM	BHP	RPM	BHP	RPM	BHP	RPM	BHP	
30000	1208	459	12.6																			
32000	1288	468	13.5	508	16.7																	
34000	1369	477	14.6	515	17.8																	
36000	1449	486	15.7	524	19.0	560	22.5															
38000	1530	496	16.9	533	20.4	567	23.9	601	27.7													
40000	1610	507	18.2	542	21.7	576	25.4	609	29.3	640	33.2											
44000	1771	528	20.9	562	24.8	595	28.7	626	32.8	655	36.9	684	41.2									
48000	1932	550	24.1	583	28.2	615	32.4	645	36.7	673	41.1	700	45.6	728	50.2	754	54.9					
52000	2093	575	27.6	605	31.9	636	36.4	665	40.9	692	45.6	719	50.3	744	55.1	769	60.0	794	65.1	819	70.2	
56000	2254	602	31.7	629	36.1	657	40.8	686	45.6	713	50.5	738	55.5	763	60.6	787	65.7	811	70.9	834	76.2	
60000	2415	631	36.3	655	40.9	681	45.7	707	50.7	733	55.9	759	61.1	783	66.4	806	71.8	829	77.3	851	82.8	
65000	2616	668	42.7	690	47.6	713	52.6	736	57.9	761	63.3	785	68.8	809	74.4	831	80.1	853	85.9	875	91.7	
70000	2818	706	50.1	727	55.2	747	60.5	768	65.9	790	71.6	812	77.3	835	83.3	857	89.3	879	95.4	900	101.5	
75000	3019	745	58.4	764	63.8	783	69.3	803	75.0	822	80.8	842	86.8	863	93.0	884	99.3	905	105.6	926	112.1	
80000	3220	785	67.7	803	73.4	821	79.2	838	85.2	856	91.2	875	97.4	894	103.7	913	110.2	933	116.9	952	123.7	
85000	3421	824	78.0	842	84.1	859	90.2	875	96.4	892	102.7	909	109.1	926	115.6	944	122.3	962	129.2	980	136.3	
90000	3623	865	89.6	881	95.9	897	102.3	913	108.8	929	115.3	945	122.0	961	128.8	977	135.7	993	142.8	1010	150.0	
95000	3824	906	102.3	921	108.9	937	115.6	952	122.4	967	129.3	982	136.2	997	143.2	1012	150.4	1027	157.6	1042	165.1	
100000	4025	947	116.2	962	123.2	976	130.3	991	137.3	1005	144.4	1019	151.7	1033	158.9	1048	166.4	1062	173.8	1076	181.4	
105000	4226	988	131.6	1002	138.9	1016	146.2	1030	153.6	1044	161.0	1057	168.5	1071	176.1	1084	183.7	1098	191.5	1111	199.2	
110000	4428	1030	148.4	1043	155.9	1057	163.5	1070	171.2	1083	178.9	1096	186.8	1109	194.5	1122	202.6	1135	210.4	1147	218.6	
115000	4629	1071	166.5	1084	174.4	1098	182.4	1110	190.3	1123	198.5	1135	206.4	1148	214.7	1160	222.7	1172	231.1	1184	239.3	
120000	4830	1113	186.2	1126	194.5	1138	202.7	1151	211.1	1163	219.3	1175	227.8	1187	236.1	1199	244.8	1210	253.1	1222	261.9	
125000	5031	1155	207.6	1168	216.2	1180	224.6	1192	233.3	1203	241.9	1215	250.6	1226	259.3	1238	268.1	1249	277.0	1260	285.7	
Volume		7"SP		8"SP		9"SP		10"SP		11"SP		12"SP		13"SP		14"SP		15"SP		16"SP		
CFM	FPM	RPM	BHP	RPM	BHP	RPM	BHP	RPM	BHP	RPM	BHP	RPM	BHP	RPM	BHP	RPM	BHP	RPM	BHP	RPM	BHP	
56000	2254		857	81.6																		
60000	2415		873	88.5	916	99.9	958	111.7														
65000	2616		896	97.7	936	109.6	976	122.0	1016	134.7												
70000	2818		920	107.7	960	120.4	997	133.2	1034	146.3	1071	159.7	1107	173.5								
75000	3019		946	118.7	984	131.9	1021	145.4	1056	159.1	1091	173.1	1125	187.2	1159	201.7	1192	216.4				
80000	3220		972	130.5	1010	144.3	1045	158.4	1080	172.7	1113	187.2	1146	201.9	1178	216.9	1210	232.2	1242	247.7	1273	263.3
85000	3421		999	143.3	1036	157.9	1071	172.5	1105	187.4	1137	202.5	1169	217.8	1200	233.4	1231	249.1	1261	264.9	1291	281.1
90000	3623		1027	157.3	1062	172.3	1097	187.7	1130	203.2	1162	218.9	1194	234.8	1224	250.9	1253	267.1	1282	283.5	1311	300.4
95000	3824		1058	172.5	1091	188.0	1124	203.9	1156	220.0	1188	236.4	1219	253.0	1248	269.5	1277	286.3	1305	303.3	1333	320.8
100000	4025		1091	189.1	1121	205.0	1152	221.3</														

Wheel Diameter = 54.25 in.
 Outlet Area = 30.41 sq. ft. inside
 Maximum BHP = 242 x (RPM/1000)³
 Tip Speed, fpm = 14.2 x RPM

Size

5425 DIDW

Class I RPM 748
 Class II RPM 974
 Class III RPM 1226

Design 5020 Centrifugal BI Fans

Volume O.Vel		1/4"SP		3/8"SP		1/2"SP		5/8"SP		3/4"SP		7/8"SP		1"SP		1-1/4"SP		1-1/2"SP		1-3/4"SP	
CFM	FPM	RPM	BHP	RPM	BHP	RPM	BHP	RPM	BHP	RPM	BHP	RPM	BHP	RPM	BHP	RPM	BHP	RPM	BHP	RPM	BHP
26000	854	202	2.0	218	2.5	235	3.0	251	3.6	265	4.2	280	4.8	294	5.4						
28000	919	213	2.3	227	2.8	243	3.4	258	4.0	273	4.6	286	5.3	300	5.9	325	7.3				
30000	985	224	2.7	237	3.2	251	3.8	266	4.5	280	5.1	294	5.8	306	6.5	331	7.9	354	9.4		
32000	1051	235	3.1	248	3.7	261	4.3	274	4.9	288	5.6	301	6.3	314	7.0	337	8.5	360	10.1		
34000	1116	247	3.5	259	4.1	271	4.8	283	5.5	296	6.2	309	6.9	324	7.7	344	9.2	366	10.8	387	12.4
36000	1182	259	4.0	270	4.7	281	5.3	293	6.0	304	6.8	317	7.5	329	8.3	351	9.9	373	11.6	393	13.3
38000	1248	270	4.6	281	5.2	292	5.9	303	6.7	314	7.4	325	8.2	337	9.0	359	10.7	380	12.4	399	14.2
40000	1314	282	5.2	293	5.9	303	6.6	313	7.4	323	8.1	334	9.0	345	9.8	367	11.5	387	13.3	406	15.1
44000	1445	307	6.6	316	7.3	325	8.1	335	8.9	344	9.8	353	10.6	363	11.5	382	13.3	402	15.2	421	17.2
48000	1576	331	8.2	340	9.0	349	9.9	357	10.8	365	11.6	374	12.5	382	13.5	400	15.4	418	17.4	436	19.5
52000	1708	356	10.1	364	11.0	372	11.9	380	12.9	388	13.8	395	14.8	403	15.7	419	17.7	435	19.8	452	22.0
56000	1839	380	12.3	388	13.3	396	14.3	403	15.3	411	16.3	418	17.3	425	18.3	439	20.4	454	22.6	469	24.9
60000	1970	405	14.8	413	15.9	420	16.9	427	18.0	434	19.0	441	20.1	447	21.2	461	23.4	474	25.7	488	28.1
65000	2134	437	18.5	444	19.6	450	20.7	457	21.9	463	23.0	470	24.2	476	25.3	488	27.7	501	30.1	513	32.6
70000	2299	468	22.7	475	23.9	481	25.1	487	26.3	493	27.6	499	28.8	505	30.0	517	32.5	528	35.1	540	37.7
75000	2463	500	27.5	506	28.8	512	30.1	518	31.4	524	32.7	529	34.0	535	35.3	546	38.0	556	40.7	567	43.5
80000	2627	532	33.0	537	34.4	543	35.8	549	37.1	554	38.5	559	39.9	565	41.4	575	44.2	585	47.0	595	49.9
85000	2791	564	39.2	569	40.7	574	42.1	579	43.6	585	45.1	590	46.5	595	48.0	605	51.0	614	54.0	624	57.1
90000	2955	595	46.2	601	47.7	606	49.3	611	50.8	615	52.4	620	53.9	625	55.5	635	58.7	644	61.8	653	65.0
95000	3120	627	54.0	632	55.6	637	57.2	642	58.8	646	60.5	651	62.1	656	63.8	665	67.0	674	70.4	682	73.7
100000	3284	659	62.5	664	64.3	669	66.0	673	67.7	678	69.4	682	71.1	686	72.8	695	76.3	704	79.8	712	83.3
105000	3448	691	72.0	696	73.9	700	75.6	705	77.4	709	79.3	713	81.0	717	82.8	726	86.5	734	90.1	742	93.8
110000	3612	723	82.5	728	84.4	732	86.2	736	88.1	740	90.0	744	91.9	748	93.8	756	97.5	764	101.3	772	105.2
115000	3776	755	93.9	760	95.8	764	97.8	768	99.8	772	101.7	776	103.7	780	105.7	787	109.6	795	113.6	802	117.5
120000	3941	788	106.3	792	108.3	796	110.4	799	112.4	803	114.5	807	116.5	811	118.6	818	122.7	825	126.8	832	131.0
130000	4269	852	134.3	856	136.6	859	138.8	863	141.1	866	143.2	870	145.5	873	147.7	880	152.2	887	156.5	894	161.0
Volume O.Vel	2"SP		2-1/2"SP		3"SP		3-1/2"SP		4"SP		4-1/2"SP		5"SP		5-1/2"SP		6"SP		6-1/2"SP		
CFM	FPM	RPM	BHP	RPM	BHP	RPM	BHP	RPM	BHP	RPM	BHP	RPM	BHP	RPM	BHP	RPM	BHP	RPM	BHP	RPM	BHP
36000	1182	413	15.0																		
38000	1248	418	16.0																		
40000	1314	425	17.0	461	20.9																
44000	1445	439	19.2	473	23.3	505	27.5														
48000	1576	454	21.6	486	25.9	517	30.4	547	35.0												
52000	1708	469	24.3	501	28.9	530	33.6	559	38.5	586	43.4	613	48.6								
56000	1839	485	27.2	516	32.1	545	37.0	572	42.1	598	47.4	624	52.8	649	58.2						
60000	1970	502	30.5	531	35.6	560	40.8	587	46.2	612	51.6	636	57.2	660	62.9	684	68.7	707	74.7		
65000	2134	526	35.1	552	40.4	579	45.9	605	51.6	630	57.4	654	63.3	677	69.3	699	75.4	721	81.6	743	87.9
70000	2299	551	40.3	575	45.8	600	51.6	624	57.6	649	63.7	672	69.9	694	76.1	716	82.5	737	89.0	757	95.6
75000	2463	578	46.2	599	52.0	622	58.0	645	64.1	668	70.5	691	77.1	713	83.7	734	90.4	754	97.2	774	104.0
80000	2627	605	52.8	625	58.8	645	65.0	667	71.4	688	78.0	710	84.9	732	91.8	752	98.8	772	105.9	791	113.1
85000	2791	633	60.1	652	66.4	671	72.8	690	79.5	710	86.3	730	93.3	751	100.5	771	107.9	791	115.3	810	122.9
90000	2955	662	68.2	680	74.8	697	81.4	715	88.3	733	95.3	752	102.6	771	110.1	791	117.7	810	125.4	829	133.3
95000	3120	691	77.1	708	83.9	724	90.9	741	98.0	758	105.2	775	112.7	793	120.4	811	128.3	830	136.3	848	144.4
100000	3284	720	86.9	736	94.0	752	101.2	768	108.6	784	116.1	800	123.7	816	131.6	833	139.7	851	148.0	868	156.3
105000	3448	749	97.4	765	104.9	780	112.4	795	120.1	810	127.9	825	135.7	841	143.8	856	152.0	873	160.5	889	169.1
110000	3612	779	109.0	794	116.8	809	124.6	823	132.5	837	140.5	852	148.7	866	157.0	881	165.4	896	174.1	911	183.0
115000	3776	809	121.6	824	129.6	838	137.7	851	146.0	865	154.3	879	162.7	892	171.2	906	180.0	920	188.7	934	197.8
120000	3941	839	135.1	853	143.5	867	152.0	880	160.4	893	169.0	906	177.8	919	186.5	932	195.4	946	204.6	959	213.7
130000	4269	900	165.5	913	174.5	926	183.5	938	192.7	950	201.8	962	211.1	974	220.5	986	229.9	998	239.5	1010	249.0
140000	4597	962	200.5	974	210.1	986	219.9	997	229.5	1009	239.4	1020	249.1	1031	259.2	1042	269.0	1053	279.3	1064	289.2
150000	4926	1023	240.4	1035	250.8	1046	260.9	1057	271.5	1068	281.7	1078	292.3	1089	302.6	1099	313.3	1110	323.9	1120	334.6
Volume O.Vel	7"SP		8"SP		9"SP		10"SP		11"SP		12"SP		13"SP		14SP		15"SP		16"SP		
CFM	FPM	RPM	BHP	RPM	BHP	RPM	BHP	RPM	BHP	RPM	BHP	RPM	BHP	RPM	BHP	RPM	BHP	RPM	BHP	RPM	BHP
65000	2134	764	94.3																		
70000	2299	778	102.4	818	116.0																
75000	2463	793	111.0	832	125.3	869	139.9														
80000	2627	810	120.4	847	135.1	883	150.2	918	165.8												
85000	2791	828	130.4	864	145.7	898	161.4	932	177.4	965	193.8	998	210.5								
90000	2955	847	141.1	882	157.1	915	173.3	948	189.8	979	206.7	1011	223.9	1042	241.6						
95000	3120	866	152.5	901	169.3	933	186.1	965	203.2	995	220.6	1026	238.3	1056	256.5	1085	274.8	1114	293.4		
100000	3284	885	164.7	919	182.1	952	199.6	982	217.3	1012	235.3	1042	253.6	1071	272.3	1099	290.9	1127	310.0	1155	329.6
105000	3448	905	177.8	938	195.7	970	213.9	1001	232.2	1030	250.8	1059	269.7	1087	288.9	1114	308.1	1141	327.6	1168	347.7
110000	3612	927	191.8	958	210.3	989	229.0	1020	248.0	1049	267.2	1077	286.7	1104	306.5	1131	326.2	1157	346.3	1183	366.9
115000	3776	949	206.9	979	225.8	1009	245.0	1039	264.6	1067	284.4	1095	304.5	1122	325.0	1148	345.3	1173	365.9	1199	387.0
120000	3941	973	223.1																		

Wheel Diameter = 60.00 in.
Outlet Area = 37.24 sq. ft. inside
Maximum BHP = 401 X (RPM/1000)³
Tip Speed, fpm = 15.7 x RPM

Size

6000 DIDW

Design 5020 Centrifugal BI Fans

Class I RPM 677
Class II RPM 881
Class III RPM 1109

Volume		1/4"SP		3/8"SP		1/2"SP		5/8"SP		3/4"SP		7/8"SP		1"SP		1-1/4"SP		1-1/2"SP		1-3/4"SP		
CFM	FPM	RPM	BHP	RPM	BHP	RPM	BHP	RPM	BHP	RPM	BHP	RPM	BHP	RPM	BHP	RPM	BHP	RPM	BHP	RPM	BHP	
32000	859	183	2.4	198	3.1	213	3.8	227	4.5	241	5.2	253	5.9	266	6.7							
34000	913	191	2.8	205	3.4	219	4.1	233	4.9	246	5.6	258	6.4	270	7.2	294	8.9					
36000	966	199	3.1	212	3.8	225	4.5	238	5.3	251	6.1	264	6.9	275	7.7	298	9.4					
38000	1020	208	3.5	220	4.2	232	5.0	244	5.8	257	6.6	269	7.4	280	8.3	302	10.1	323	11.9			
40000	1074	216	3.9	228	4.7	239	5.4	251	6.3	263	7.1	275	8.0	286	8.9	307	10.7	327	12.6	347	14.6	
44000	1181	234	4.9	244	5.7	254	6.5	264	7.4	275	8.3	286	9.2	297	10.2	318	12.1	337	14.1	355	16.2	
48000	1289	251	6.0	261	6.9	270	7.8	279	8.7	289	9.6	299	10.6	309	11.6	329	13.7	347	15.9	365	18.0	
50000	1342	260	6.7	269	7.6	278	8.5	287	9.4	296	10.4	305	11.4	315	12.4	335	14.6	353	16.8	370	19.0	
54000	1450	278	8.1	287	9.0	295	10.0	303	11.0	311	12.0	320	13.1	328	14.1	346	16.4	364	18.7	381	21.1	
56000	1503	287	8.9	295	9.9	304	10.9	312	11.9	319	12.9	327	14.0	336	15.1	353	17.4	370	19.8	387	22.2	
60000	1611	305	10.6	313	11.7	321	12.7	328	13.8	336	14.9	343	16.0	350	17.2	366	19.5	382	22.0	398	24.6	
65000	1745	328	13.1	335	14.2	343	15.4	350	16.5	356	17.7	363	18.9	370	20.1	377	21.3	384	22.6	391	23.9	
70000	1879	351	16.0	358	17.2	365	18.4	371	19.6	378	20.9	384	22.2	391	23.4	397	24.7	403	26.1	410	27.4	
75000	2013	374	19.2	381	20.5	387	21.8	393	23.2	399	24.5	405	25.8	411	27.2	417	28.6	423	29.9	429	31.4	
80000	2148	397	23.0	403	24.3	410	25.7	415	27.1	421	28.5	427	30.0	433	31.4	438	32.9	444	34.3	449	35.8	
85000	2282	420	27.2	426	28.6	432	30.1	438	31.6	443	33.1	449	34.6	454	36.1	459	37.6	465	39.2	470	40.7	
90000	2416	444	31.9	449	33.4	455	35.0	460	36.6	466	38.1	471	39.7	476	41.3	481	42.9	486	44.5	491	46.1	
95000	2550	467	37.1	473	38.8	478	40.4	483	42.0	488	43.7	493	45.4	498	47.0	503	48.7	508	50.4	512	52.1	
100000	2685	491	43.0	496	44.6	501	46.4	506	48.1	511	49.9	515	51.6	520	53.3	525	55.1	529	56.8	534	58.6	
105000	2819	514	49.4	519	51.1	524	53.0	529	54.7	533	56.6	538	58.4	542	60.2	547	62.1	551	63.9	556	65.7	
110000	2953	538	56.4	543	58.2	547	60.1	552	62.0	556	63.9	561	65.8	565	67.7	569	69.6	573	71.6	578	73.5	
115000	3087	561	64.0	566	66.0	570	68.0	575	70.0	579	71.9	583	73.9	587	75.9	591	77.9	596	79.9	600	82.0	
120000	3221	585	72.4	589	74.5	594	76.5	598	78.6	602	80.6	606	82.7	610	84.8	614	86.9	618	88.9	622	91.0	
130000	3490	632	91.3	637	93.5	640	95.7	644	97.9	648	100.2	652	102.4	656	104.6	659	106.9	663	109.2	667	111.4	
140000	3758	680	113.2	684	115.6	687	118.1	691	120.4	695	122.8	698	125.2	702	127.6	705	130.0	709	132.4	712	134.8	
150000	4027	727	138.5	731	141.1	734	143.7	738	146.2	741	148.8	745	151.3	748	153.9	751	156.5	754	159.0	758	161.5	
Volume		2"SP		2-1/2"SP		3"SP		3-1/2"SP		4"SP		4-1/2"SP		5"SP		5-1/2"SP		6"SP		6-1/2"SP		
CFM	FPM	RPM	BHP	RPM	BHP	RPM	BHP	RPM	BHP	RPM	BHP	RPM	BHP	RPM	BHP	RPM	BHP	RPM	BHP	RPM	BHP	
44000	1181	373	18.4																			
48000	1289	382	20.3	415	25.0																	
52000	1396	392	22.4	423	27.3	453	32.4															
56000	1503	403	24.7	433	29.9	461	35.2	489	40.7													
60000	1611	414	27.2	443	32.6	470	38.2	497	44.0	523	49.9											
65000	1745	428	30.7	457	36.4	483	42.2	508	48.3	533	54.5	557	60.9									
70000	1879	443	34.5	471	40.5	497	46.7	521	53.0	545	59.5	567	66.1	590	72.9	612	79.9					
75000	2013	459	38.7	485	45.0	511	51.5	535	58.1	557	64.9	579	71.9	601	78.9	622	86.1	643	93.5			
80000	2148	477	43.4	501	49.9	525	56.7	549	63.7	571	70.8	592	78.6	613	85.3	633	92.8	653	100.4			
85000	2282	496	48.7	517	55.3	540	62.4	563	69.7	585	77.1	606	84.0	626	92.2	645	100.0	664	107.9	683	115.9	
90000	2416	515	54.4	535	61.3	556	68.6	578	76.1	599	83.9	620	91.7	639	99.6	659	107.7	677	115.9	695	124.3	
95000	2550	535	60.7	554	67.9	573	75.3	593	83.1	614	91.1	634	99.3	653	107.6	672	116.0	690	124.5	708	133.1	
100000	2685	556	67.7	574	75.1	591	82.7	610	90.7	629	98.9	648	107.4	668	116.0	686	124.7	704	133.5	721	142.4	
105000	2819	577	75.1	594	82.8	610	90.8	628	98.9	645	107.4	664	116.0	682	124.9	700	134.0	718	143.1	735	152.3	
110000	2953	598	83.3	614	91.3	630	99.5	646	107.8	663	116.4	680	125.3	697	134.5	715	143.8	732	153.3	749	162.8	
115000	3087	619	92.1	635	100.3	650	108.8	665	117.4	681	126.2	697	135.3	713	144.7	730	154.2	747	164.0	763	173.9	
120000	3221	641	101.6	656	110.2	670	118.9	685	127.8	700	136.9	715	146.1	730	155.6	746	165.4	762	175.3	778	185.5	
130000	3490	685	122.7	698	131.9	712	141.2	725	150.7	739	160.2	752	169.9	766	179.9	780	190.1	794	200.5	809	211.0	
140000	3758	729	147.0	742	156.8	754	166.6	767	176.7	779	186.9	792	197.0	804	207.5	817	218.2	830	228.8	843	239.8	
150000	4027	773	174.5	786	185.0	798	195.5	809	206.0	821	216.8	833	227.6	844	238.5	856	249.7	867	260.8	879	272.2	
160000	4295	818	205.7	830	216.7	841	227.8	853	239.2	863	250.3	874	261.8	885	273.2	896	284.8	907	296.6	917	308.4	
170000	4564	864	240.6	875	252.2	886	264.2	896	275.8	907	287.9	917	299.7	927	311.9	937	323.9	947	336.3	957	348.5	
180000	4832	909	279.5	920	292.0	930	304.2	940	316.8	950	329.2	960	341.9	970	354.4	979	367.3	989	379.9	998	393.0	
Volume		7"SP		8"SP		9"SP		10"SP		11"SP		12"SP		13"SP		14"SP		15"SP		16"SP		
CFM	FPM	RPM	BHP	RPM	BHP	RPM	BHP	RPM	BHP	RPM	BHP	RPM	BHP	RPM	BHP	RPM	BHP	RPM	BHP	RPM	BHP	
80000	2148	692	116.1																			
85000	2282	702	124.2	738	140.8																	
90000	2416	713	132.7	748	149.9	782	167.6															
95000	2550	725	141.7	759	159.5	792	177.7	825	196.4													
100000	2685	738	151.4	771	169.8	803	188.4	834	207.6	865	227.3											
105000	2819	752	161.6	784	180.6	815	199.8	845	219.5	875	239.6	904	260.2									
110000	2953	765	172.4	797	192.0	827	211.8	857	232.0	885	252.6	914	273.7	942	295.2							
115000	3087	780	183.8	811	204.0	840	224.4	869	245.2	897	266.3	924	287.9	952	309.9	979	332.4					
120000	3221	794	195.8	825	216.6	854	237.6	882	259.0	909	280.8	936	302.9	962	325.3	989	348.3	1015	371.6	1040	395.0	
130000	3490	823	221.8	853	243.8	882	266.2	909	289.0	936	311.9	961	335.1	986	358.5	1011	382.3	1035	406.6	1059	431.3	
140000	3758	856	251.1	883	274.0	910	297.4	937														

Wheel Diameter = 66.00 in.
 Outlet Area = 45 sq. ft. inside
 Maximum BHP = 646 x (RPM/1000)³
 Tip Speed, fpm = 17.3 x RPM

Size

6600 DIDW

Design 5020 Centrifugal BI Fans

Class I RPM 615
 Class II RPM 801
 Class III RPM 1008

Volume O.Vel		1/4"SP		3/8"SP		1/2"SP		5/8"SP		3/4"SP		7/8"SP		1"SP		1-1/4"SP		1-1/2"SP		1-3/4"SP	
CFM	FPM	RPM	BHP	RPM	BHP	RPM	BHP	RPM	BHP	RPM	BHP	RPM	BHP	RPM	BHP	RPM	BHP	RPM	BHP	RPM	BHP
40000	887	170	3.1	183	3.9	196	4.8	209	5.6	221	6.5	233	7.5	244	8.4						
44000	976	183	3.8	194	4.7	206	5.6	218	6.5	230	7.5	241	8.5	251	9.5	271	11.6				
48000	1065	195	4.7	206	5.6	216	6.5	227	7.5	238	8.5	249	9.5	259	10.6	278	12.8	297	15.1	315	17.5
52000	1154	208	5.6	218	6.6	227	7.5	237	8.6	247	9.6	257	10.7	268	11.9	286	14.2	304	16.6	321	19.1
56000	1242	222	6.7	230	7.7	239	8.7	248	9.8	257	10.9	267	12.1	276	13.3	295	15.7	312	18.3	328	20.9
60000	1331	235	7.9	243	9.0	251	10.1	260	11.2	268	12.4	276	13.6	285	14.8	303	17.4	320	20.1	336	22.8
65000	1442	252	9.7	260	10.8	267	12.0	275	13.2	282	14.4	290	15.7	298	17.0	306	18.3	314	19.7	322	21.1
70000	1553	269	11.7	276	12.9	283	14.1	290	15.4	297	16.7	304	18.0	311	19.4	319	20.8	326	22.2	334	23.7
75000	1664	286	14.0	293	15.3	299	16.6	306	18.0	313	19.3	319	20.7	326	22.1	332	23.6	339	25.1	346	26.6
80000	1775	303	16.6	309	18.0	316	19.4	322	20.8	328	22.2	334	23.7	341	25.2	347	26.7	353	28.2	359	29.8
85000	1886	320	19.5	326	21.0	333	22.5	339	24.0	344	25.5	350	27.0	356	28.6	362	30.1	367	31.7	373	33.4
90000	1997	337	22.8	343	24.3	349	25.9	355	27.5	361	29.1	366	30.7	372	32.3	377	34.0	382	35.6	388	37.3
95000	2108	355	26.4	361	28.0	366	29.7	372	31.4	377	33.0	382	34.7	387	36.4	393	38.1	398	39.9	403	41.6
100000	2219	372	30.4	378	32.1	383	33.9	388	35.6	394	37.4	399	39.1	404	40.9	409	42.7	413	44.5	418	46.4
105000	2330	390	34.8	395	36.7	400	38.5	405	40.3	410	42.1	415	44.0	420	45.9	425	47.7	429	49.6	434	51.5
110000	2441	407	39.7	412	41.6	417	43.5	422	45.4	427	47.3	432	49.3	436	51.2	441	53.2	445	55.1	450	57.1
120000	2662	443	50.8	447	52.8	452	54.9	456	56.9	461	59.0	465	61.1	469	63.2	474	65.3	478	67.4	482	69.6
130000	2884	478	63.8	482	66.0	487	68.2	491	70.4	495	72.7	499	75.0	503	77.2	507	79.5	511	81.8	515	84.0
140000	3106	513	78.9	518	81.3	521	83.6	525	86.1	529	88.4	533	90.9	537	93.3	541	95.7	544	98.1	548	100.7
150000	3328	549	96.2	553	98.8	557	101.3	560	103.9	564	106.6	567	109.1	571	111.6	575	114.3	578	116.9	581	119.4
160000	3550	585	116.0	588	118.8	592	121.5	595	124.2	599	127.0	602	129.8	605	132.4	609	135.2	612	138.0	615	140.8
170000	3772	620	138.4	624	141.3	627	144.3	630	147.1	634	150.0	637	153.0	640	155.9	643	158.8	646	161.7	649	164.6
180000	3994	656	163.6	659	166.6	662	169.8	666	172.8	669	175.9	672	179.0	675	182.1	678	185.2	681	188.2	684	191.2
190000	4215	692	191.6	695	194.9	698	198.2	701	201.4	704	204.6	707	207.9	710	211.1	712	214.4	715	217.7	718	220.8
Volume O.Vel		2"SP		2-1/2"SP		3"SP		3-1/2"SP		4"SP		4-1/2"SP		5"SP		5-1/2"SP		6"SP		6-1/2"SP	
CFM	FPM	RPM	BHP	RPM	BHP	RPM	BHP	RPM	BHP	RPM	BHP	RPM	BHP	RPM	BHP	RPM	BHP	RPM	BHP	RPM	BHP
52000	1154	337	21.7																		
56000	1242	344	23.5																		
60000	1331	351	25.6	380	31.3																
65000	1442	360	28.3	388	34.4	415	40.7														
70000	1553	371	31.3	397	37.6	423	44.2	448	51.1												
75000	1664	381	34.6	408	41.2	432	48.1	456	55.2	479	62.5										
80000	1775	392	38.1	418	45.1	442	52.3	465	59.7	487	67.2	508	75.0								
85000	1886	404	42.0	429	49.2	452	56.8	474	64.4	496	72.3	516	80.3	537	88.5	557	97.0				
90000	1997	416	46.2	439	53.7	463	61.6	484	69.5	505	77.8	525	86.0	545	94.5	564	103.2	583	112.1		
95000	2108	429	50.8	451	58.6	473	66.7	495	75.0	515	83.5	535	92.1	554	100.9	572	109.9	591	119.0	609	128.4
100000	2219	443	55.8	463	63.8	484	72.2	506	80.8	526	89.6	545	98.6	563	107.7	581	116.9	599	126.3	616	135.9
105000	2330	457	61.3	476	69.5	496	78.1	516	87.0	536	96.1	555	105.4	573	114.8	591	124.3	608	134.1	625	143.8
110000	2441	472	67.2	490	75.6	508	84.4	528	93.6	547	103.0	566	112.6	584	122.3	601	132.2	618	142.2	634	152.2
120000	2662	502	80.5	518	89.3	535	98.6	552	108.2	570	118.1	587	128.2	605	138.6	622	149.0	638	159.7	654	170.5
130000	2884	534	95.7	549	105.1	563	114.8	579	124.8	594	135.1	610	145.8	627	156.7	643	167.7	659	179.0	674	190.3
140000	3106	566	113.0	580	123.0	593	133.3	607	143.8	621	154.5	636	165.5	650	176.9	666	188.5	681	200.3	696	212.3
150000	3328	598	132.6	611	143.3	624	154.1	637	165.1	650	176.3	663	187.8	676	199.5	690	211.6	704	223.8	718	236.2
160000	3550	631	154.7	644	166.0	656	177.5	668	189.0	680	200.7	692	212.6	704	224.8	716	237.2	729	249.8	742	262.8
170000	3772	665	179.4	676	191.3	688	203.3	699	215.4	710	227.8	722	240.1	733	252.8	744	265.8	756	278.7	768	292.0
180000	3994	698	206.8	709	219.3	720	232.1	731	244.7	742	257.5	752	270.7	763	283.7	773	297.1	784	310.6	795	324.3
190000	4215	732	237.2	743	250.4	753	263.5	763	276.9	773	290.4	783	303.9	794	317.8	803	331.4	814	345.6	824	359.6
200000	4437	766	270.7	776	284.3	786	298.3	796	312.2	806	326.2	815	340.5	825	354.6	834	369.2	844	383.5	853	398.4
210000	4659	800	307.3	810	321.7	819	336.3	829	350.7	838	365.6	847	380.1	856	395.2	865	409.9	874	425.1	883	440.2
220000	4881	834	347.4	844	362.6	853	377.5	862	392.9	871	407.9	880	423.6	888	438.7	897	454.5	906	469.8	914	485.7
Volume O.Vel		7"SP		8"SP		9"SP		10"SP		11"SP		12"SP		13"SP		14"SP		15"SP		16"SP	
CFM	FPM	RPM	BHP	RPM	BHP	RPM	BHP	RPM	BHP	RPM	BHP	RPM	BHP	RPM	BHP	RPM	BHP	RPM	BHP	RPM	BHP
100000	2219	634	145.5																		
105000	2330	641	153.7	674	174.3																
110000	2441	650	162.4	682	183.5	713	205.0														
120000	2662	669	181.2	699	203.3	728	225.8	757	248.9	785	272.7										
130000	2884	690	201.9	718	225.0	746	248.8	773	273.0	800	297.7	826	322.9								
140000	3106	710	224.3	739	249.0	766	273.7	792	299.0	817	324.7	842	350.9	867	377.7	891	405.0				
150000	3328	732	249.0	760	274.7	786	300.9	812	327.5	836	354.4	860	381.6	883	409.2	906	437.2	929	465.8	952	495.1
160000	3550	755	276.0	781	302.8	807	330.1	832	357.9	856	386.0	879	414.4	902	443.2	924	472.6	946	502.1	967	531.8
170000	3772	780	305.7	804	333.5	829	361.9	853	390.9	877	420.2	900	450.0	922	480.1	943	510.3	964	540.7	985	571.8
180000	3994	806	338.3	828	366.9	852	396.3	875	426.4	898	457.0	921	488.1	942	519.3	963	550.5	984	582.3	1004	614.8
190000	4215	834	374.1	854	403.5	876	433.7	898	464.7	920	496.5	942	528.6	963	560.9	984	593.5	1004	626.6		
200000	4437	863	413.0	882	443.2	902	474.3	922	506.1	943	538.8	964	572.0	984	605.4	1005					

Wheel Diameter = 73.00 in.
 Outlet Area = 55.14 sq. ft. inside
 Maximum BHP = 1070 x (RPM/1000)³
 Tip Speed, fpm = 19.1 x RPM

Size

7300 DIDW

Class I RPM 556
 Class II RPM 725

Design 5020 Centrifugal BI Fans

Volume O.Vel		1/4"SP		1/2"SP		3/4"SP		1"SP		1-1/4"SP		1-1/2"SP		1-3/4"SP		2"SPSP		2-1/4"SP		2-1/2"SP	
CFM	FPM	RPM	BHP	RPM	BHP	RPM	BHP	RPM	BHP	RPM	BHP	RPM	BHP	RPM	BHP	RPM	BHP	RPM	BHP	RPM	BHP
48000	871	152	3.7	176	5.7	199	7.8	219	10.1												
52000	943	161	4.4	183	6.4	205	8.7	224	11.1	243	13.6										
56000	1016	170	5.1	190	7.3	211	9.7	230	12.2	248	14.8	265	17.5								
60000	1088	180	6.0	198	8.2	217	10.7	236	13.4	253	16.1	270	18.9	286	21.9						
65000	1179	192	7.2	208	9.6	226	12.2	244	15.0	261	17.9	277	20.9	292	24.0	307	27.1				
70000	1269	204	8.6	220	11.2	235	13.9	252	16.8	269	19.8	284	23.0	298	26.2	313	29.5	326	32.9	340	36.4
75000	1360	216	10.2	231	12.9	245	15.7	261	18.8	277	22.0	292	25.3	306	28.6	319	32.1	332	35.7	345	39.3
80000	1451	229	12.0	243	14.9	256	17.8	270	21.0	285	24.3	299	27.7	313	31.3	327	34.9	339	38.6	352	42.3
85000	1542	241	14.0	254	17.0	267	20.1	280	23.4	294	26.8	307	30.4	321	34.1	334	37.9	347	41.7	358	45.6
90000	1632	254	16.2	267	19.4	279	22.7	291	26.1	303	29.6	316	33.3	329	37.2	342	41.1	354	45.1	366	49.1
95000	1723	266	18.7	279	22.1	290	25.5	302	29.0	313	32.6	325	36.5	337	40.4	350	44.5	362	48.7	373	52.9
100000	1814	279	21.5	291	25.0	302	28.5	313	32.2	324	36.0	335	39.9	346	44.0	358	48.2	370	52.5	381	56.9
105000	1904	292	24.5	303	28.1	314	31.9	324	35.7	334	39.6	345	43.6	356	47.8	367	52.2	378	56.6	389	61.2
110000	1995	305	27.8	316	31.6	326	35.5	336	39.4	345	43.5	355	47.7	365	52.0	376	56.4	386	61.0	397	65.6
115000	2086	318	31.4	328	35.4	338	39.4	347	43.5	357	47.7	366	52.0	376	56.4	385	61.0	395	65.6	406	70.4
120000	2176	331	35.3	341	39.4	350	43.6	359	47.9	368	52.2	377	56.7	386	61.2	395	65.9	405	70.6	414	75.5
125000	2267	343	39.5	353	43.8	362	48.2	371	52.6	380	57.1	389	61.7	397	66.4	406	71.2	415	76.0	424	81.0
130000	2358	356	44.1	366	48.5	375	53.1	383	57.7	392	62.3	400	67.0	408	71.8	417	76.7	425	81.7	434	86.9
135000	2448	369	49.0	378	53.6	387	58.3	395	63.1	404	67.9	412	72.8	420	77.7	428	82.8	436	87.8	444	93.0
140000	2539	382	54.3	391	59.1	400	63.9	408	68.9	416	73.8	423	78.9	431	83.9	439	89.1	446	94.3	454	99.7
145000	2630	395	60.0	404	64.9	412	70.0	420	75.1	428	80.2	435	85.3	443	90.5	450	95.9	457	101.2	465	106.7
150000	2720	409	66.0	417	71.2	425	76.4	432	81.6	440	86.8	447	92.2	454	97.6	462	103.0	469	108.5	476	114.1
155000	2811	422	72.5	430	77.8	437	83.1	445	88.5	452	93.9	459	99.5	466	105.0	473	110.6	480	116.3	487	121.9
160000	2902	435	79.4	442	84.8	450	90.3	457	95.9	464	101.5	471	107.1	478	112.8	485	118.6	492	124.4	498	130.2
165000	2992	448	86.7	455	92.3	463	98.0	470	103.7	477	109.5	483	115.2	490	121.1	497	127.0	503	132.9	510	139.0
170000	3083	461	94.4	468	100.2	475	106.1	482	112.0	489	117.9	496	123.8	502	129.9	508	135.9	515	142.0	521	148.1
175000	3174	474	102.6	481	108.6	488	114.6	495	120.7	501	126.7	508	132.9	514	139.0	520	145.2	527	151.5	533	157.8
180000	3264	487	111.3	494	117.5	501	123.7	507	129.9	514	136.1	520	142.4	526	148.7	533	155.2	538	161.4	545	168.0
185000	3355	500	120.5	507	126.8	514	133.3	520	139.5	526	146.0	532	152.4	539	158.9	545	165.4	550	171.9	556	178.5
190000	3446	513	130.2	520	136.7	527	143.2	533	149.7	539	156.4	545	162.9	551	169.6	557	176.2	563	183.0	568	189.6
200000	3627	540	151.1	546	158.0	552	164.8	558	171.7	564	178.5	570	185.4	576	192.4	581	199.4	587	206.4	592	213.6
210000	3808	566	174.2	572	181.5	578	188.6	584	195.8	589	202.9	595	210.3	600	217.4	606	224.8	611	232.1	616	239.4
220000	3990	592	199.5	598	207.2	604	214.6	610	222.2	615	229.6	620	237.2	625	244.8	631	252.3	636	260.1	641	267.7
230000	4171	619	227.3	625	235.2	630	243.0	635	250.9	640	258.8	645	266.5	651	274.6	655	282.4	660	290.3	665	298.5
Volume O.Vel	3"SP		3-1/2"SP		4"SP		5"SP		6"SP		7"SP		8"SP		9"SP		10"SP		11"SP		
CFM	FPM	RPM	BHP	RPM	BHP	RPM	BHP	RPM	BHP	RPM	BHP	RPM	BHP	RPM	BHP	RPM	BHP	RPM	BHP	RPM	BHP
80000	1451	376	50.1																		
85000	1542	382	53.6	404	62.0																
90000	1632	388	57.5	410	66.0	431	74.9														
95000	1723	395	61.5	416	70.3	437	79.5														
100000	1814	403	65.9	423	74.9	443	84.4	481	103.9												
105000	1904	410	70.4	430	79.8	450	89.6	486	109.5												
110000	1995	418	75.2	438	85.0	457	95.0	492	115.5	527	137.0										
115000	2086	426	80.3	446	90.4	464	100.7	499	121.8	533	143.8										
120000	2176	434	85.7	453	96.1	472	106.7	506	128.4	539	150.9	570	174.4								
125000	2267	442	91.4	461	102.1	479	113.0	513	135.4	545	158.5	576	182.4	606	207.1						
130000	2358	451	97.4	469	108.4	487	119.6	521	142.7	552	166.3	582	190.7	611	216.0						
135000	2448	460	103.9	478	115.0	495	126.6	528	150.3	559	174.7	588	199.5	617	225.4	645	251.6				
140000	2539	470	110.6	487	122.1	503	134.0	536	158.2	566	183.1	595	208.7	623	234.9	650	261.7	677	289.4		
145000	2630	480	117.9	496	129.6	512	141.5	544	166.4	574	192.0	602	218.2	629	244.9	656	272.3	682	300.6		
150000	2720	490	125.5	505	137.4	521	149.6	552	175.1	582	201.3	610	228.0	636	255.4	663	283.5	688	312.0	713	341.3
155000	2811	501	133.6	515	145.7	530	158.2	560	184.1	590	211.0	617	238.3	644	266.4	669	294.7	694	323.8	718	353.6
160000	2902	512	142.1	525	154.4	539	167.1	568	193.5	597	220.9	625	249.1	651	277.5	676	306.6	700	336.3	724	366.6
165000	2992	523	151.2	536	163.7	549	176.6	577	203.5	605	231.4	633	260.0	658	289.2	683	319.1	707	349.2		
170000	3083	534	160.6	546	173.3	559	186.4	586	213.6	613	242.2	640	271.5	666	301.3	690	331.5	714	362.3		
175000	3174	545	170.5	557	183.5	569	196.9	595	224.6	622	253.4	648	283.4	674	313.8	698	344.8	721	376.3		
180000	3264	556	181.0	568	194.3	580	207.8	604	235.8	630	265.3	656	295.6	682	327.0						

Wheel Diameter = 80.75 in.
 Outlet Area = 67.46 sq. ft. inside
 Maximum BHP = 1771 x (RPM/1000)³
 Tip Speed, fpm = 21.1 x RPM

Class I RPM 503
 Class II RPM 655

Size

8075 DIDW

Design 5020 Centrifugal BI Fans

Volume O.Vel		1/4"SP		1/2"SP		3/4"SP		1"SP		1-1/4"SP		1-1/2"SP		1-3/4"SP		2"SP		2-1/4"SP		2-1/2"SP	
CFM	FPM	RPM	BHP	RPM	BHP	RPM	BHP	RPM	BHP	RPM	BHP	RPM	BHP	RPM	BHP	RPM	BHP	RPM	BHP	RPM	BHP
60000	889	139	4.7	161	7.2	181	9.8	199	12.6												
65000	963	148	5.6	167	8.1	187	11.0	204	13.9	221	17.0										
70000	1038	157	6.6	174	9.3	192	12.2	210	15.3	226	18.6	241	22.0								
75000	1112	165	7.7	181	10.5	198	13.6	215	16.9	231	20.3	246	23.8	260	27.4						
80000	1186	174	9.0	189	11.9	205	15.1	221	18.5	236	22.1	251	25.7	264	29.5	278	33.4				
85000	1260	183	10.3	197	13.4	212	16.7	227	20.3	242	24.0	256	27.8	269	31.8	282	35.8	294	39.9		
90000	1334	192	11.9	206	15.1	219	18.6	233	22.2	248	26.1	262	30.1	274	34.2	287	38.4	299	42.6	311	47.0
95000	1408	201	13.6	214	17.0	227	20.6	240	24.4	254	28.4	267	32.5	280	36.7	292	41.1	304	45.5	315	50.0
100000	1482	211	15.5	223	19.1	235	22.8	247	26.6	260	30.8	273	35.1	286	39.4	298	44.0	309	48.5	320	53.2
105000	1556	220	17.6	232	21.3	243	25.1	255	29.1	267	33.4	279	37.8	291	42.3	303	47.0	314	51.7	325	56.5
110000	1630	229	19.8	241	23.7	252	27.7	263	31.8	274	36.1	286	40.7	297	45.4	309	50.2	320	55.1	331	60.0
115000	1704	239	22.3	250	26.3	260	30.4	271	34.7	281	39.2	292	43.8	303	48.6	315	53.6	326	58.7	336	63.8
120000	1779	248	24.9	259	29.1	269	33.5	279	37.8	289	42.4	299	47.2	310	52.1	321	57.2	331	62.4	342	67.7
125000	1853	257	27.8	268	32.2	278	36.6	287	41.2	297	45.9	306	50.8	317	55.8	327	61.0	337	66.4	348	71.8
130000	1927	267	30.9	277	35.5	286	40.1	296	44.8	305	49.6	314	54.6	324	59.7	333	65.1	344	70.5	354	76.2
135000	2001	276	34.3	286	38.9	295	43.8	304	48.6	313	53.6	322	58.7	331	63.9	340	69.4	350	75.0	360	80.7
140000	2075	286	37.8	295	42.7	304	47.6	313	52.7	321	57.8	330	63.0	338	68.4	347	73.9	356	79.6	366	85.5
145000	2149	295	41.7	304	46.7	313	51.8	322	57.0	330	62.2	338	67.6	346	73.1	355	78.7	363	84.6	372	90.5
150000	2223	305	45.8	314	51.0	322	56.2	330	61.6	338	67.0	346	72.5	354	78.1	362	83.9	371	89.8	379	95.9
155000	2297	314	50.2	323	55.5	331	61.0	339	66.5	347	72.0	355	77.7	362	83.4	370	89.3	378	95.3	386	101.4
160000	2371	324	54.8	332	60.3	340	65.9	348	71.6	356	77.3	363	83.1	371	89.0	378	95.0	386	101.1	393	107.4
165000	2446	334	59.8	342	65.4	350	71.2	357	77.0	365	82.8	372	88.8	379	94.9	386	101.0	393	107.2	401	113.6
170000	2520	343	65.0	351	70.8	359	76.7	366	82.7	373	88.8	381	94.9	387	101.0	394	107.3	401	113.7	408	120.2
175000	2594	353	70.6	361	76.6	368	82.6	375	88.8	382	95.0	389	101.2	396	107.5	403	113.9	410	120.5	416	127.1
180000	2668	363	76.4	370	82.6	377	88.9	384	95.1	391	101.4	398	107.8	405	114.3	411	121.0	418	127.5	424	134.3
185000	2742	372	82.6	380	89.0	387	95.4	393	101.8	400	108.3	407	114.9	413	121.6	420	128.2	426	135.0	433	141.9
190000	2816	382	89.2	389	95.7	396	102.2	403	108.8	409	115.5	416	122.3	422	129.0	428	135.8	435	142.8	441	149.7
200000	2964	401	103.2	408	110.1	415	116.9	421	123.9	427	130.9	434	137.9	440	145.0	446	152.2	452	159.3	458	166.7
210000	3113	420	118.7	427	125.9	433	133.1	440	140.5	446	147.7	452	155.1	457	162.5	463	169.9	469	177.5	475	185.0
220000	3261	440	135.8	446	143.3	452	150.9	458	158.4	464	166.0	470	173.8	475	181.4	481	189.3	486	197.0	492	205.0
230000	3409	459	154.4	465	162.3	471	170.2	477	178.0	483	186.1	488	194.0	493	202.1	499	210.1	504	218.3	509	226.4
240000	3557	479	174.7	485	183.0	490	191.2	496	199.4	501	207.7	506	215.9	512	224.3	517	232.7	522	241.2	527	249.7
250000	3705	498	196.7	504	205.4	509	213.9	515	222.5	520	231.0	525	239.7	530	248.3	535	257.2	540	265.7	545	274.6
260000	3854	518	220.6	523	229.6	528	238.4	534	247.4	539	256.1	544	265.2	548	274.1	553	283.1	558	292.3	563	301.3
270000	4002	537	246.3	542	255.7	548	264.8	553	274.1	557	283.2	562	292.5	567	301.9	571	311.1	576	320.6	581	329.9
Volume O.Vel		3"SP		3-1/2"SP		4"SP		5"SP		6"SP		7"SP		8"SP		9"SP		10"SP		11"SP	
CFM	FPM	RPM	BHP	RPM	BHP	RPM	BHP	RPM	BHP	RPM	BHP	RPM	BHP	RPM	BHP	RPM	BHP	RPM	BHP	RPM	BHP
95000	1408	337	59.3																		
100000	1482	341	62.7																		
105000	1556	346	66.4	366	76.6																
110000	1630	351	70.2	370	80.7	390	91.5														
115000	1704	356	74.2	375	85.0	394	96.1														
120000	1779	361	78.4	380	89.6	398	100.8														
125000	1853	367	82.9	385	94.3	403	105.9	437	130.1												
130000	1927	373	87.6	391	99.2	408	111.1	441	135.9												
135000	2001	379	92.5	396	104.4	413	116.7	446	141.8	477	168.2										
140000	2075	384	97.5	402	109.8	419	122.4	450	148.1	481	174.9										
145000	2149	390	102.8	408	115.5	424	128.3	455	154.7	485	182.1	514	210.5								
150000	2223	396	108.4	414	121.3	430	134.5	461	161.6	490	189.6	518	218.3								
155000	2297	403	114.2	419	127.5	436	141.0	466	168.6	495	197.1	522	226.7	549	256.9						
160000	2371	409	120.4	426	133.9	442	147.6	472	175.9	500	205.0	527	235.0	553	265.9						
165000	2446	416	126.9	432	140.5	447	154.7	477	183.6	505	213.4	532	243.7	558	275.4	583	307.5				
170000	2520	423	133.6	438	147.6	453	161.9	483	191.4	511	221.7	537	253.1	562	284.7	587	317.6				
175000	2594	430	140.7	445	154.8	460	169.4	489	199.7	516	230.6	542	262.2	567	294.8	591	328.3	615	362.3		
180000	2668	438	148.1	452	162.5	466	177.4	495	208.1	522	239.7	547	272.0	572	305.1	595	338.8	619	373.4	642	409.0
185000	2742	445	155.9	459	170.5	472	185.5	501	216.8	528	249.0	553	282.0	577	315.5	600	350.1	623	385.4	646	421.4
190000	2816	453	164.1	466	178.9	479	194.2	507	225.9	533	258.9	558	292.3	582	326.7	605	361.4	628	397.0	650	433.5
200000	2964	469	181.5	481	196.7	493	212.4	519	245.1	545	279.2	570	313.9	593	349.6	615	385.5	637	422.2		
210000	3113	486	200.4	497	216.1	508	232.2	532	265.7	557	300.9	581	336.8	604	373.9	626	410.9	647	448.8		
220000	3261	503	221.0	513	237.2	524	253.7	546	287.9	569	324.0	593	361.1	616	399.4	638	437.7				
230000	3409	520	242.9	530	259.7	540	276.8	561	312.0	583	348.7	605	387.0	627	426.3	649	466.0				
240000	3557	537	266.9	547	284.2	556	301.6	576	337.9	596	375.3	618	414.6	639	454.7						
250000	3705	554	292.3	564	310.2	573	328.4	592	365.4	611	403.9	631	443.8	651	484.8						
260000	3854	572	319.6	581	338.3	590	356.9	608	395.2	626	434.3	645	474.9								
270000	4002	590	349.1	598	368.0	607	387.3	624	426.4	642	466.7										

Northern Blower Inc. certifies that the product shown herein is licensed to bear the AMCA Seal. Fan Sound Ratings are based on tests and procedures in accordance with AMCA Publication 211 and AMCA Publication 311, and comply with the requirements of the AMCA Certified Ratings Program.

Fan sound data testing was conducted according to AMCA Standard 300 in an AMCA Registered Laboratory. The Certified Sound Ratings Seal provides increased assurance that the published sound ratings are both reliable and accurate.

Sound data was obtained in accordance with AMCA Standard 300, Reverberant Room Method for Sound Testing of Fans, published in accordance with AMCA Standard 301, Methods for Calculating Fan Sound Ratings from Laboratory Test data.

Upon request Northern Blower will provide Sound Level Ratings for any fan selection from this catalogue. Refer also to the Northern Blower Sound Bulletin.

Fan Geometry

Designations for Rotation and Discharge of Centrifugal Fans

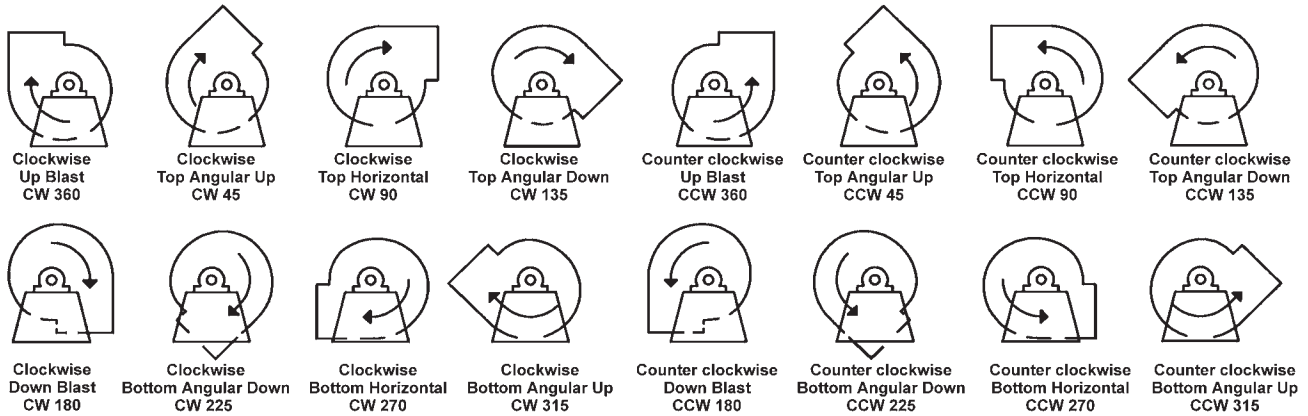

Notes:

- 1) Direction of rotation is determined from the drive side of the fan.
- 2) On single inlet fans, the drive side is always considered as the side opposite the fan inlet.
- 3) On double inlet fans with drives on both sides, the drive side is that with the higher powered drive unit.
- 4) Direction of discharge is determined in accordance with the diagrams. Angle of discharge is referred to the vertical axis of the fan and designated in degrees from such standard reference axis. Angle of discharge may be any intermediate angle as required.
- 5) For a fan inverted for ceiling suspension, or side wall mounting, the direction of rotation and discharge is determined when the fan is resting on the floor.

SW - Single Width
SI - Single Inlet

DW - Double Width
DI - Double Inlet

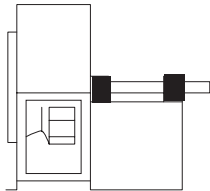

1 SWSI

For belt drive or direct connection. Impeller overhung. Two bearings on base.

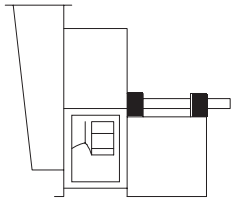

1 SWSI c/w BOX

For belt drive or direct connection. Impeller overhung. Two bearings on base. Inlet box may be self-supporting.

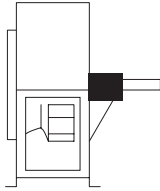

2 SWSI

For belt drive or direct connection. Impeller overhung. Bearings in bracket supported by fan housing.

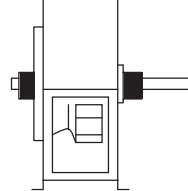

3 SWSI

For belt drive or direct connection. One bearing on each side and supported by fan housing.

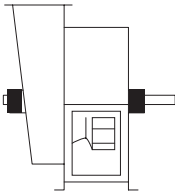

3 SWSI c/w BOX

For belt drive or direct connection. One bearing on each side and supported by fan housing and inlet box. Shaft extending through inlet box.

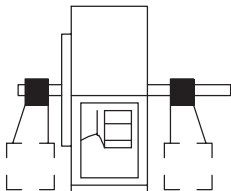

3 SWSI c/w IND. PED.

For belt drive or direct connection. Housing is self-supporting. One bearing on each side supported by independent pedestals.

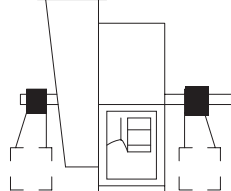

3 SWSI c/w BOX & IND. PED.

For belt drive or direct connection. Housing is self-supporting. One bearing on each side and supported by independent pedestals with shaft extending through inlet box.

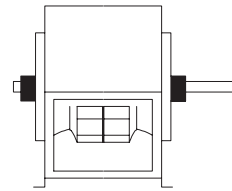

3 DWDI

For belt drive or direct connection. One bearing on each side and supported by fan housing.

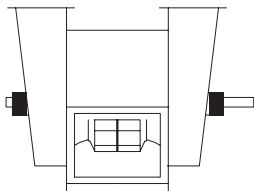

3 DWDI c/w BOXES

For belt drive or direct connection. One bearing on each side and supported by inlet boxes. Shaft extending through inlet boxes.

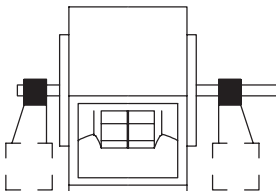

3 DWDI c/w IND. PED.

For belt drive or direct connection. Housing is self-supporting. One bearing on each side and supported by independent pedestals.

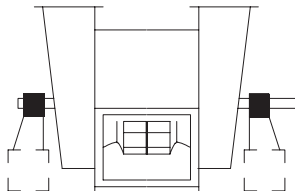

3 DWDI c/w BOXES & IND. PED.

For belt drive or direct connection. Housing is self-supporting. One bearing on each side supported by independent pedestals with shaft extending through inlet box.

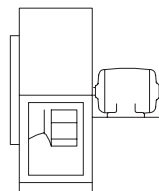

4 SWSI

For direct drive. Impeller overhung on prime mover shaft. No bearings on fan. Prime mover base mounted or integrally directly connected.

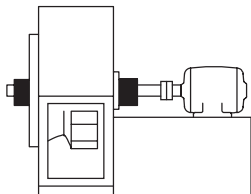

7 SWSI

For belt drive or direct connection. Arrangement 3 plus base for prime mover.

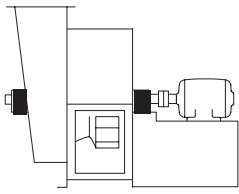

7 SWSI c/w BOX

For belt drive or direct connection. Arrangement 3 plus base for prime mover. Shaft extending through inlet box.

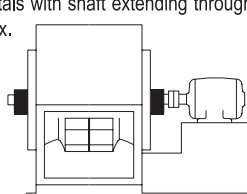

7 DWDI

For belt drive or direct connection. Arrangement 3 plus base for prime mover.

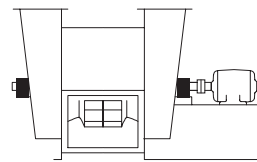

7 DWDI c/w BOXES

For belt drive or direct connection. Arrangement 3 plus base for prime mover. Shaft extending through inlet box.

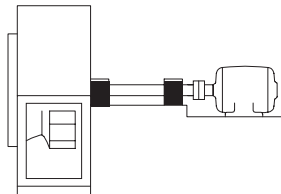

8 SWSI

For belt drive or direct connection. Arrangement 1 plus extended base for prime mover.

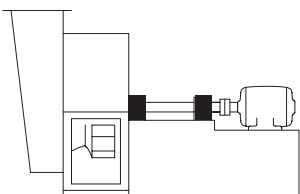

8 SWSI c/w BOX

For belt drive or direct connection. Arrangement 1 plus extended base for prime mover.

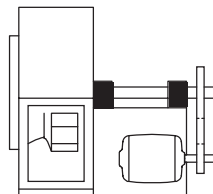

9 SWSI

For belt drive. Impeller overhung, two bearings, with prime mover outside base.

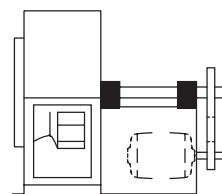

10 SWSI

For belt drive. Impeller overhung, two bearings, with prime mover inside base.



Northern Blower Inc.
901 Regent Avenue West
Winnipeg, Manitoba
Canada R2C 2Z8
☎ 204.222.4216
☎ 204.222.7601
✉ info@northernblower.com
🌐 www.northernblower.com